

ROTARY UNION

500 SERIES

AROUND THE SHAFT



Operating Parameters

MEDIA

Water, Air, Hydraulic Fluid

PRESSURE*

5,800 psi

TEMPERATURE*

248° F

SPEED*

3,000 RPM

THREADS

1/4 Inch to 1 Inch NPT

MATERIAL

Nickel Treated Carbon Steel Construction

* See Performance Charts For Details

FEATURES & BENEFITS

Shaft Mounted Design

- Used in conjunction with the customer's shaft and retaining sleeve.

Two Configurations

- High speed, low pressure applications, or high pressure, low speed applications.

Flexible Installation

- Can be installed anywhere on the shaft, singly or in series, due to in-line design.

High Pressure, Low Speed

- High pressure, low speed models can be used at pressures to 5,800 psi and speeds less than 100 RPM.

High Speed, Low Pressure

- High speed, low pressure models can be used at speeds to 3,000 RPM, and pressures to 175 psi.

Part Numbers - 500 Series Rotary Unions

Customer Shaft Size	Nickel Plated Steel				Stainless Steel			
	High-Pressure, Low-Speed		High-Speed, Low-Pressure		High-Pressure, Low-Speed		High-Speed, Low-Pressure	
	Part Number	Description	Part Number	Description	Part Number	Description	Part Number	Description
20mm	750905C	BAT20RK	750935C	BAT20RKVR	750920C	BAT20RI	750950C	BAT20RIVR
30mm	750906C	BAT30RK	750936C	BAT30RKVR	750921C	BAT30RI	750951C	BAT30RIVR
40mm	750907C	BAT40RK	750937C	BAT40RKVR	750922C	BAT40RI	750952C	BAT40RIVR
45mm	750908C	BAT45RK	750938C	BAT45RKVR	750923C	BAT45RI	750953C	BAT45RIVR
50mm	750909C	BAT50RK	750939C	BAT50RKVR	750924C	BAT50RI	750954C	BAT50RIVR
55mm	750910C	BAT55RK	750940C	BAT55RKVR	750925C	BAT55RI	750954C	BAT55RIVR
60mm	750911C	BAT60RK	750941C	BAT60RKVR	750926C	BAT60RI	750956C	BAT60RIVR
65mm	750912C	BAT65RK	750942C	BAT65RKVR	750927C	BAT65RI	750957C	BAT65RIVR
70mm	750913C	BAT70RK	750943C	BAT70RKVR	750928C	BAT70RI	750958C	BAT70RIVR
75mm	750914C	BAT75RK	750944C	BAT75RKVR	750929C	BAT75RI	750959C	BAT75RIVR
80mm	750915C	BAT80RK	750945C	BAT80RKVR	750930C	BAT80RI	750960C	BAT80RIVR
85mm	750916C	BAT85RK	750946C	BAT85RKVR	750931C	BAT85RI	750961C	BAT85RIVR
90mm	750917C	BAT90RK	750947C	BAT90RKVR	750932C	BAT90RI	750962C	BAT90RIVR
95mm	750918C	BAT95RK	750948C	BAT95RKVR	750933C	BAT95RI	750963C	BAT95RIVR
100mm	750919C	BAT100RK	750949C	BAT100RKVR	750934C	BAT100RI	750964C	BAT100RIVR

* 2 seals per joint

High-Pressure, Low-Speed

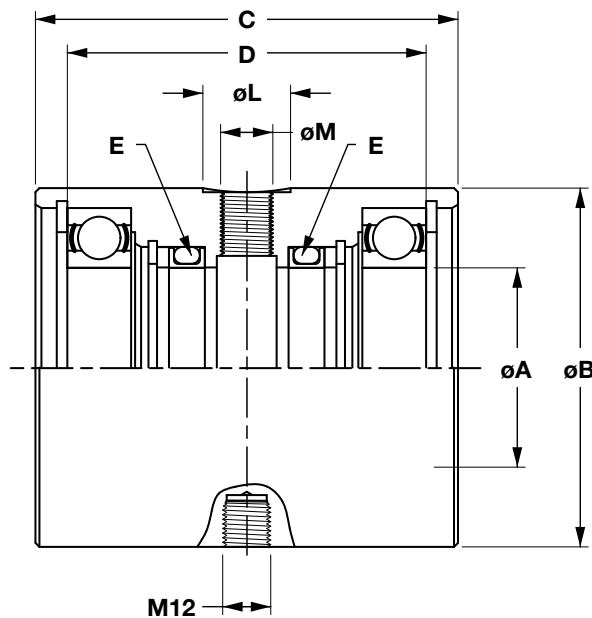

High-Speed, Low-Pressure

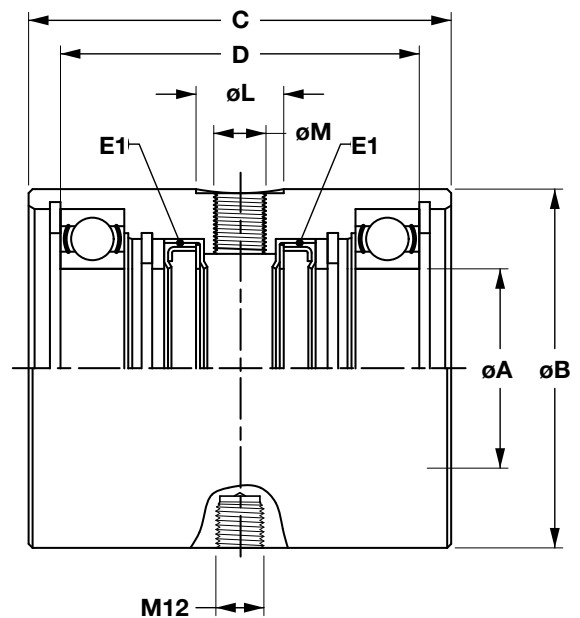

Dimensions - 500 Series Rotary Unions

Customer Shaft Size	A	B	C	D	E*	E1*	L	M
20mm	0.75	2.16	3.50	3.03	GR20	OAB20	.86	.25
30mm	1.18	2.55	3.58		GR30	OAB30		
40mm	1.57	2.95	3.93	3.38	GR40	OAB40		
45mm	1.77	3.34	4.09	3.54	GR45	OAB45		
50mm	1.96	3.54	4.17		GR50	OAB50		
55mm	2.16	3.93	4.68	4.05	GR55	OAB55	1.25	.50
60mm	2.36	4.13	4.76	4.13	GR60	OAB60		
65mm	2.55	4.33	4.84	4.21	GR65	OAB65		
70mm	2.75	4.72	5.00		GR70	OAB70		
75mm	2.95	4.92	5.27	4.48	GR75	OAB75		
80mm	3.14	5.31	5.43	4.64	GR80	OAB80		
85mm	3.34	5.51	5.51	4.72	GR85	OAB85		
90mm	3.54	5.90	5.59	4.80	GR90	OAB90		
95mm	3.74	6.10	5.78	5.00	GR95	OAB95		
100mm	3.93	6.29	6.02	5.07	GR100	OAB100		

* 2 seals per joint

ROTARY UNION

500 SERIES

HIGH PRESSURE

Performance Charts

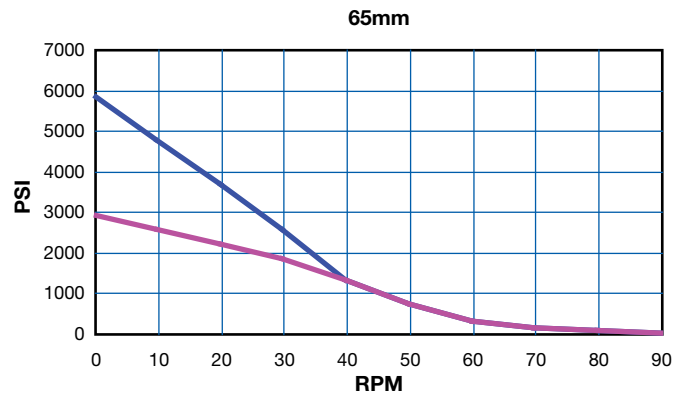
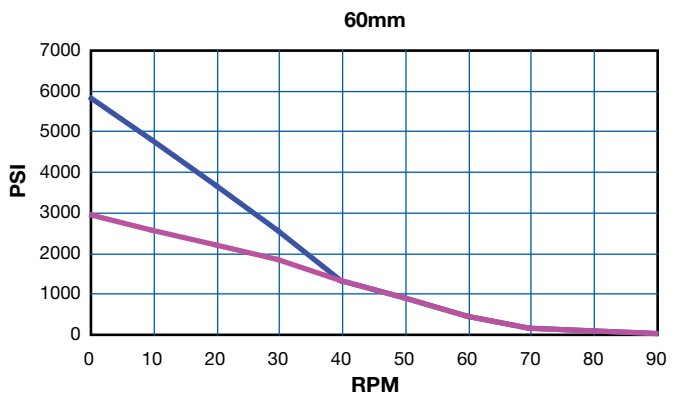
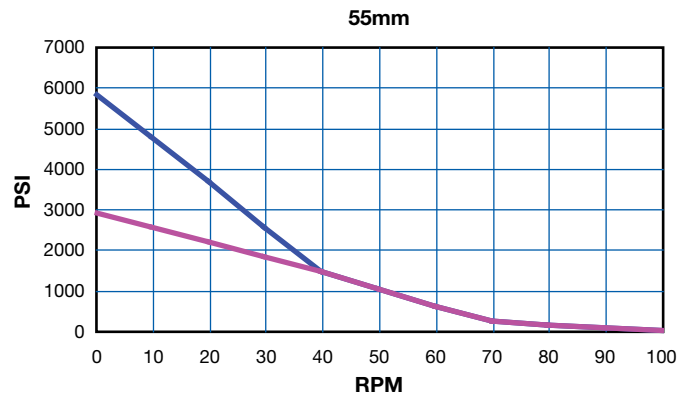
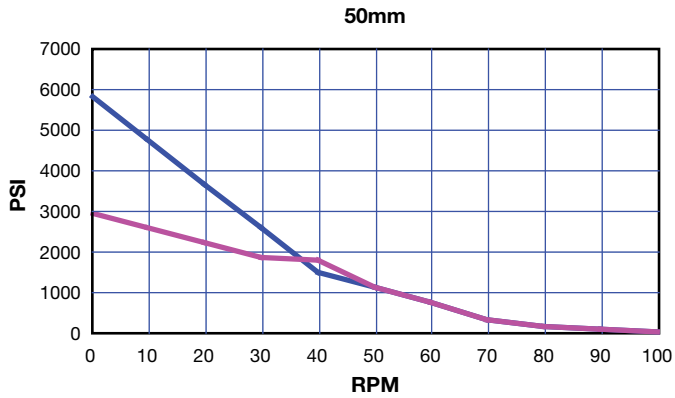
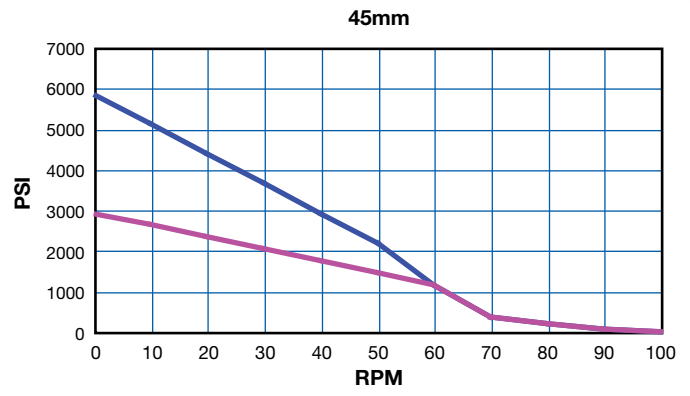
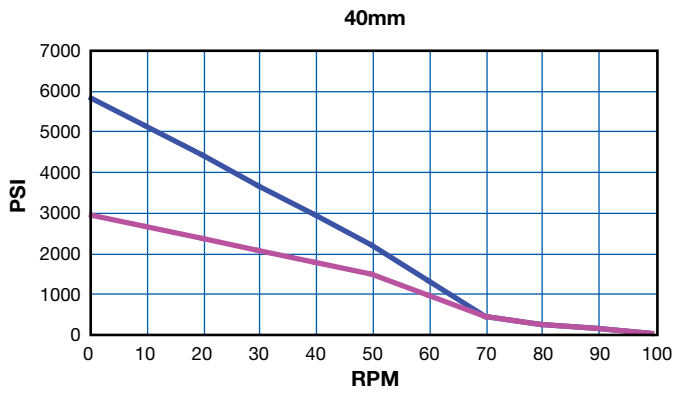
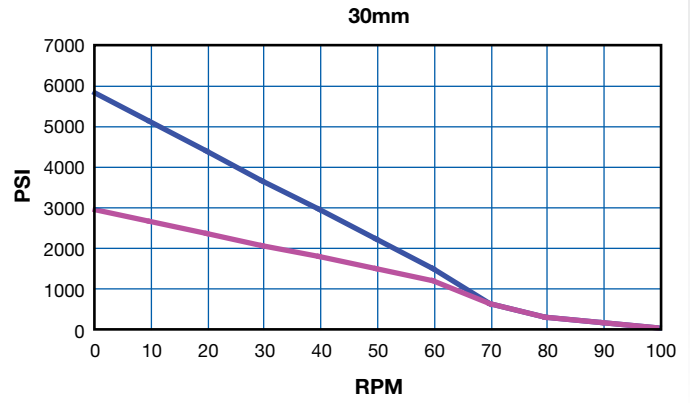
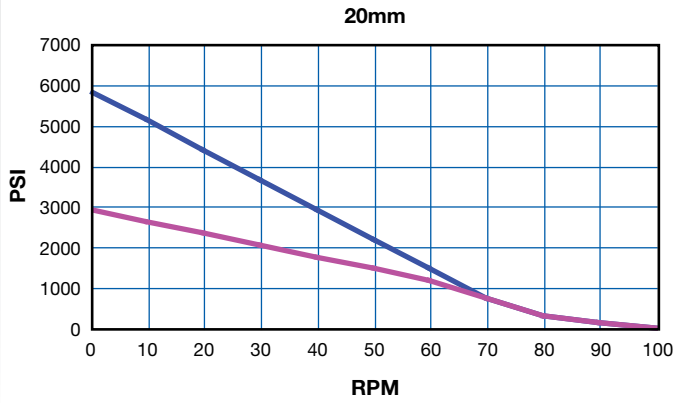

Performance Charts

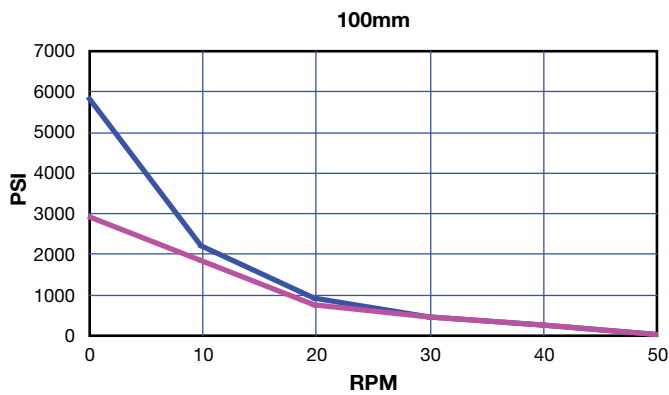
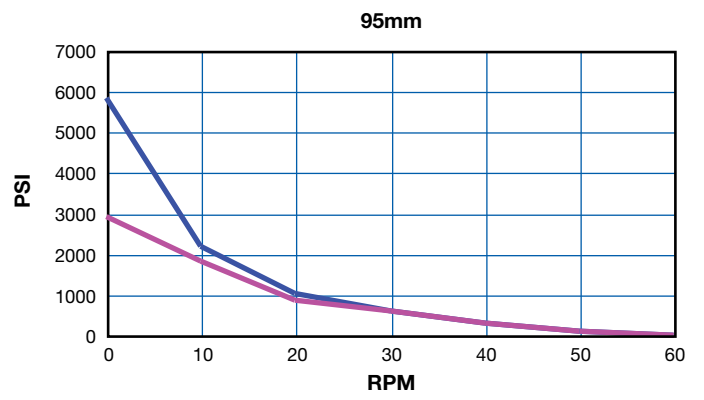
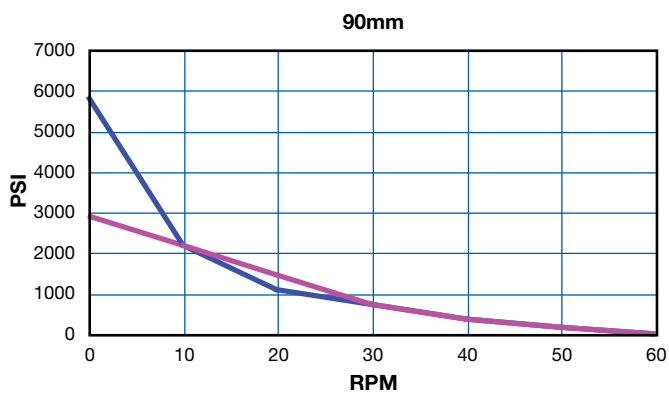
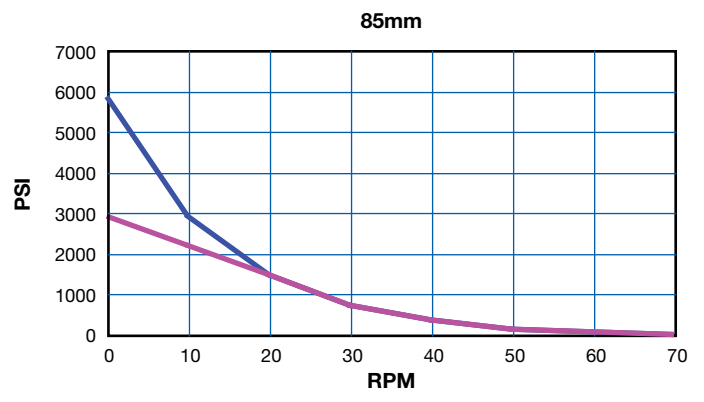
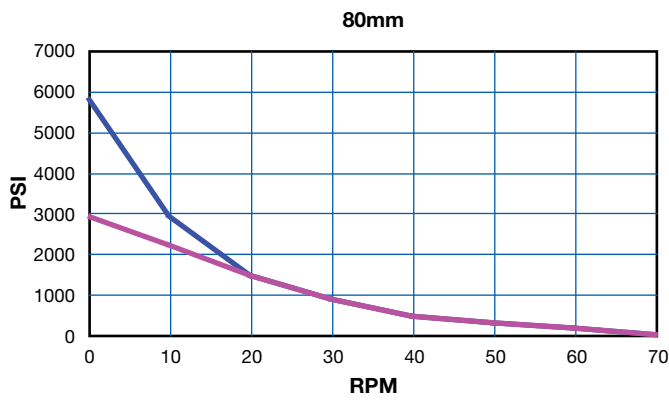
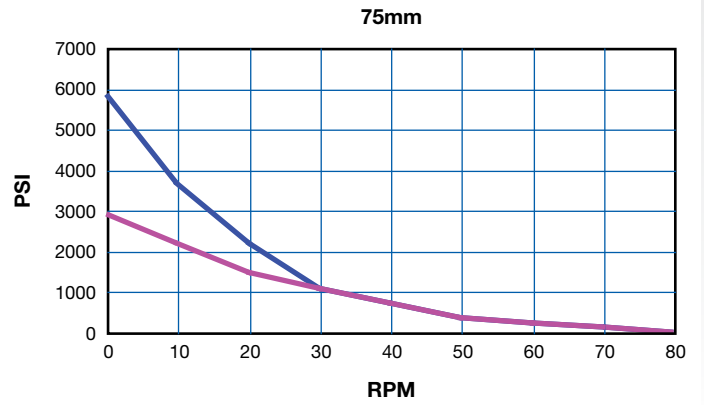
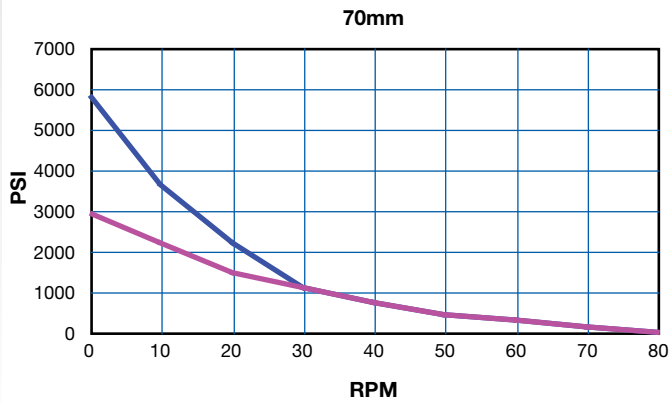

■ Standard Material
■ Stainless Steel

ROTARY UNION

500 SERIES

HIGH PRESSURE

Performance Charts

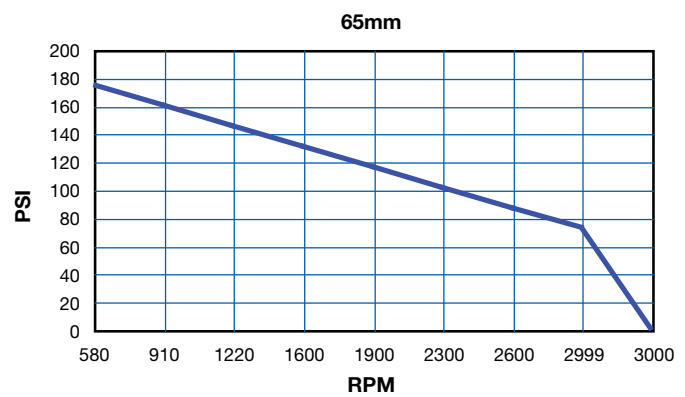
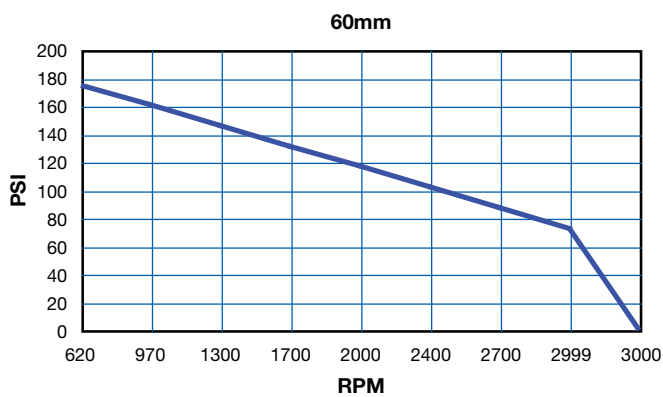
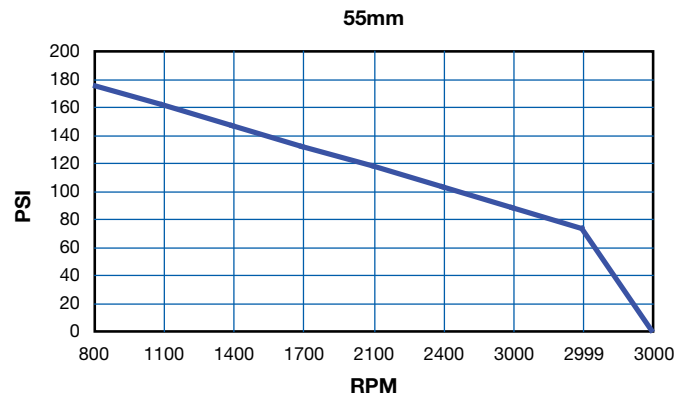
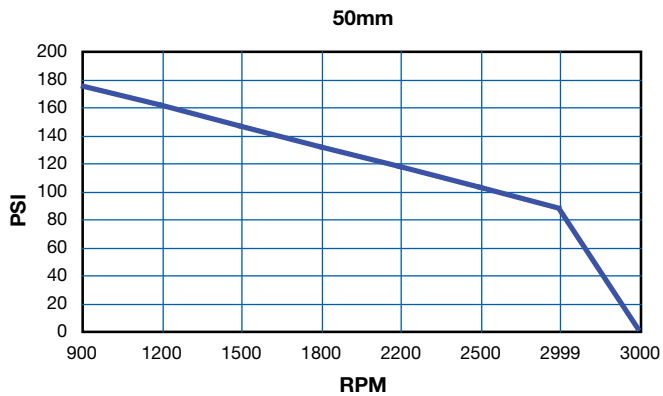
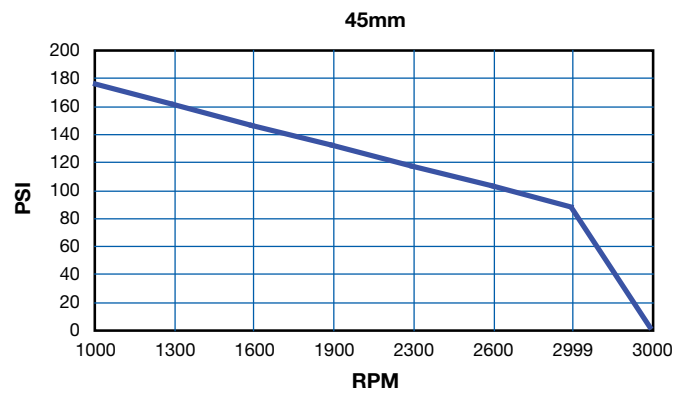
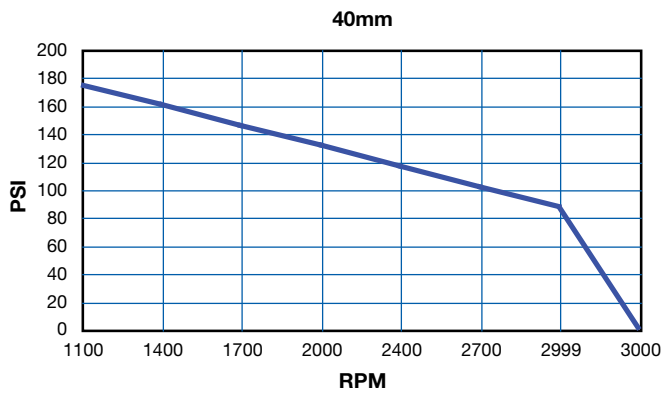
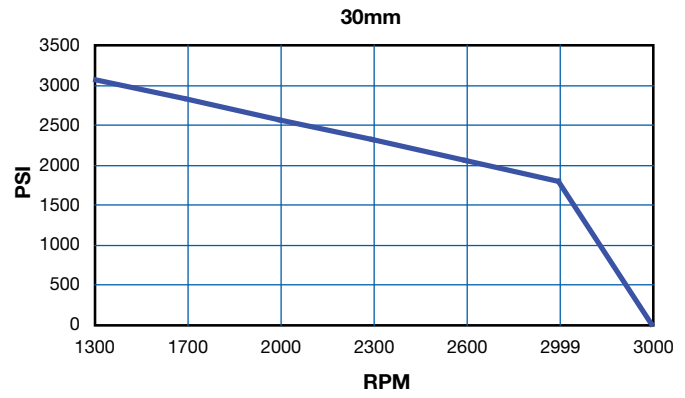
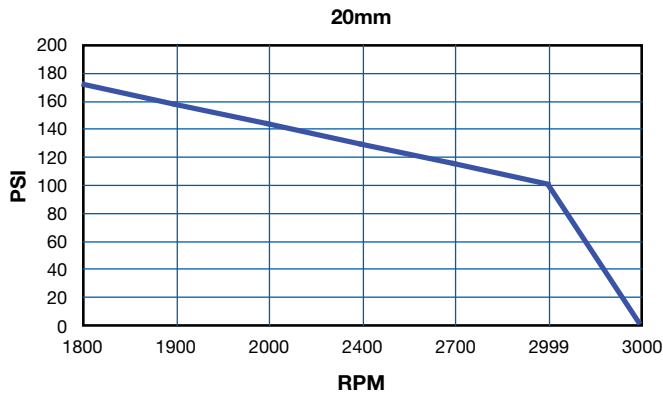

Performance Charts

70mm

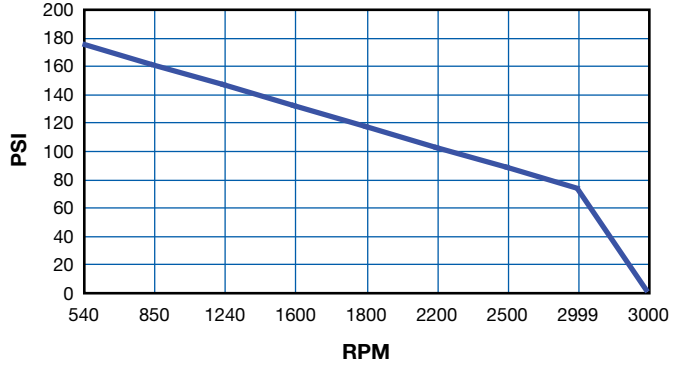

75mm

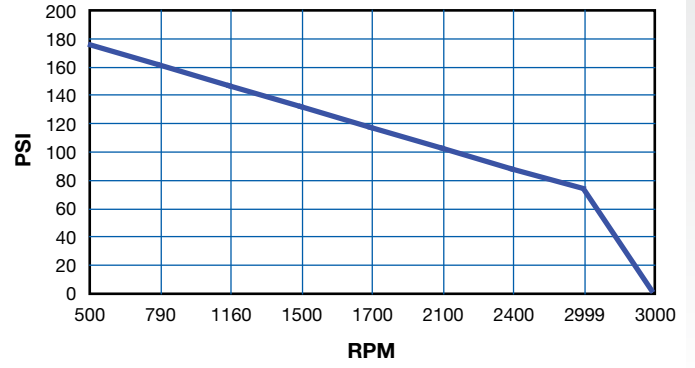

80mm

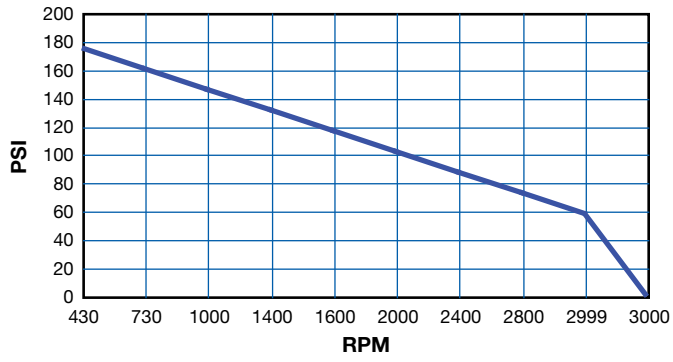

85mm

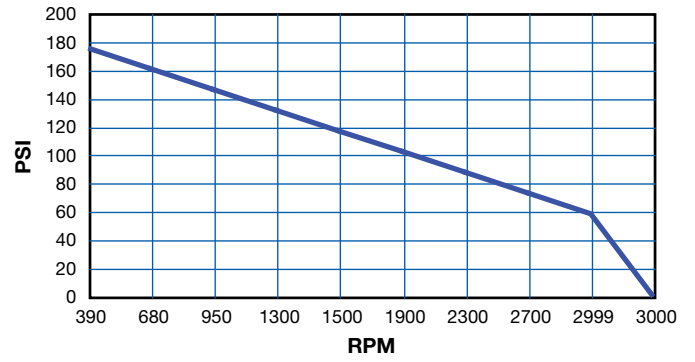

90mm

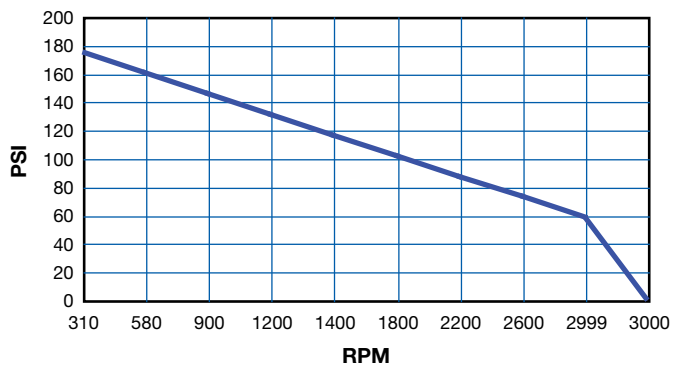

95mm

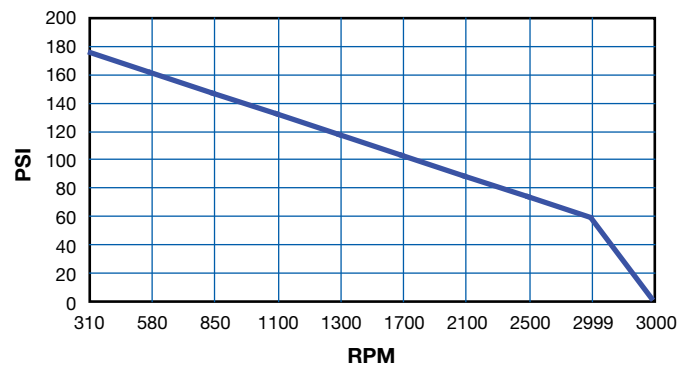

100mm

