



EXPERTS IN WATER CHEMISTRY SINCE 1903



3054 Filming Amine Analyzer User Manual



WALTRON CUSTOMER COMMITMENT

This instruction manual is a technical guide to aid the customer in the set-up, operation, and maintenance of their new Waltron measuring system. Waltron provides continuous product improvement and reserves the right to make any modifications to the information contained herein without notice.

*Copyright © Waltron Bull & Roberts, LLC, 2021
All Rights Reserved*

Technical questions concerning this product should be addressed to:

Waltron Technical Service Department

Flemington, New Jersey

Phone: (908)-534-5100

Fax: (908)-534-5546

www.waltron.net

Please be ready to provide the following information:

- Date analyzer was purchased
- Analyzer model and serial number
- Recent maintenance history
- Calibration slope values and detailed description of problem

Waltron's technical expertise and extensive experience provides personalized solutions to the water quality industry. It is Waltron's commitment to provide the customer with timely and accurate technical service and support.

Waltron fully expects the customer to be satisfied with the quality and performance of this product.

If there are any questions or concerns regarding this product, please feel free to contact Waltron at (908)-534-5100.

Thank you for choosing Waltron!

Please note the Waltron mailing and shipping address:

Waltron Bull & Roberts, LLC
25 Minneakoning Road, Suite 101
Flemington, NJ 08822



SAFETY

Please observe proper safety and handling precautions when installing, operating, maintaining, and servicing this product. The following should be noted and adhered to:

- Read and understand manual before working with analyzer.
- Pay special attention to warning labels on enclosures, containers, packages and chemicals.
- Only qualified personnel should be involved in the installation, operation, and servicing of the analyzer.
- Follow safety precautions when operating analyzer in conditions of high pressure and/or temperature.
- Keep analyzer chemicals away from heat and extreme temperatures. Reagent powders must be kept dry.
- Follow all regulations and warning labels when disposing of chemicals. Do not mix chemicals.

To obtain analyzer safety information or Safety Data Sheets (SDS), please contact Waltron or visit the website at www.waltron.net.



WARRANTY AGREEMENT

If, within one year from the date of shipment, the customer experiences any equipment defects or is not satisfied with the analyzer manufacturing, Waltron will repair, or at its option, replace any defective part(s) free of charge. This warranty requires that the defective part(s) be returned to Waltron with shipping charges prepaid.

At Waltron discretion, a Technical Service Specialist may be sent out to repair or replace the defective part(s) on location. Traveling time and expenses of the Technical Service Specialist is at the customer's expense.

Equipment sent to Waltron must be appropriately packaged and the following information must be provided prior to returning to Waltron:

- The Return Authorization (RA) number assigned to the customer by the Waltron Technical Service Department
- Customer name, address and department
- Name and telephone number of the individual responsible for returning items for repair
- Brief problem description

Ship to Waltron service center:

Waltron Bull & Roberts, LLC
25 Minneakoning Road, Suite 101
Flemington, NJ 08822

The Waltron Warranty Agreement:

- Covers expendable sensors for one month after shipment and reusable electrodes for six months after shipment.
- Does not apply to damages occurred during shipping.
- Warranty will be nullified if goods have been used for purposes other than those for which they are intended or if any seal has been removed, broken or tampered with or if the Waltron trademark or serial number has been removed, defaced, or altered.
- Does not cover expendable supply items such as reagents, tubing and electrolytes.
- Does not cover misuse or mistreatment by the user.
- Does not cover previous repair or alteration by unauthorized individuals.

Waltron does not assume responsibility for contingent liability through alleged failure or failures of products or product accessories.



CHECKLIST OF MATERIALS

In order to ensure customer satisfaction, Waltron does its best to provide adequate and timely packaging and shipping services. Please perform the following after receiving a shipment:

- Inspect all shipping containers upon receipt and record any visible damage. If there are any outward signs of damage, please retain all containers and packages for inspection by carrier. Please retain all packing material so that it can be used for future moving and shipping needs.
- Check all items received against those on the packing list. Chemicals are usually shipped in a separate package and will be itemized accordingly.
- Verify that the number of packages received agrees with the packing list and shipping papers.
- Notify both Waltron and the carrier if any problems occur.

Important Notice:

- All analyzers are inspected and tested prior to shipment.
- In normal use, the unit should require only minor maintenance and should operate correctly and without fault over a long period of time.
- Please note that if electronic components need to be replaced, it may be necessary to adjust and/or calibrate the analyzer.
- Failure to carry out correct maintenance procedures may result in inaccurate analyzer readings.



TABLE OF CONTENTS

Waltron Customer Commitment	1
Safety.....	2
Warranty Agreement.....	3
Checklist of Materials	4
Table of Contents	5
List of Figures	7
List of Tables.....	8
1 Overview	9
1.1 Specifications.....	9
1.1.1 Performance	9
1.1.2 Sample Operating Conditions	9
1.1.3 Signal Outputs	10
1.1.4 Operational Calibration	10
1.2 Safety Precautions, Instructions, and Hazards.....	10
1.2.1 General Information	10
1.2.2 List of Warnings and Potential Dangers	11
1.2.3 Reagents	12
1.2.4 Sample	12
1.2.5 Waste Disposal.....	12
1.2.6 Analyzer General Hazards	12
2 Introduction	15
2.1 Analyzer Description	15
2.2 Applications	16
2.3 Working Principle	16
2.4 Analysis Cycle	18
2.4.1 Programming Commands	18
2.4.2 Flow Diagram.....	19
2.4.3 Analyzer Operations	19
2.5 Fast Loop Reservoir.....	20
2.6 Wet-Section Box	22
2.7 Electronics	23
3 Installation	24
3.1 Receiving.....	24
3.2 Analyzer Handling.....	24
3.3 Location and Mounting.....	24
3.4 Pre-Installation.....	24
3.5 Mounting Schematics.....	25
3.6 Electrical Connections	27
3.6.1 AC Power Connection.....	27



3.6.2	User Signal Connections	28
3.7	Reagent Information	29
3.8	Reagent Holding Bracket	29
4	Analyzer Initial Start-Up	30
4.1	Preparing the Analyzer for Start-Up	30
5	User Interface	31
5.1	User Instructions	31
5.2	User Password	31
5.3	Main Screen.....	32
5.4	Reagent Refill	33
5.5	Run Menu	34
5.6	Display Menu	35
5.6.1	Display Process Values	35
5.6.2	Chart.....	35
5.6.3	Manual Step	35
5.7	Data Logger	36
5.7.1	Save to USB	36
5.8	Program Menu	37
5.8.1	Settings Menu.....	37
5.8.2	Calibration Menu.....	38
5.9	Service Menu.....	39
6	Operation	40
6.1	Reagents Prime	40
6.2	Blank Calibration.....	40
6.3	Slope (Factor) Calibration	41
6.4	Single Analysis Cycle.....	41
6.5	Online Measurement.....	42
6.6	Grab Sample.....	42
6.7	Emergency Stop	43
7	Maintenance	44
7.1	Scheduled Maintenance	44
7.2	Sample Pump Tubing Replacement.....	46
7.3	Drain Pinch Valve Tubing Replacement.....	47
7.4	Reagent Pump Tubing Replacement	47
8	Analyzer Shut-Down	49
9	Troubleshooting.....	50
10	Spare Parts	51
Appendix A – Panel Mount Schematics		52



LIST OF FIGURES

Figure 2.1: Waltron 3054 Analyzer front view.	15
Figure 2.2: Waltron 3054 inside view with electrical box and liquids box shown.	16
Figure 2.3: Color development.....	17
Figure 2.4: Flow diagram.....	19
Figure 2.5: Depiction of the fast-loop reservoir.....	21
Figure 2.6: Mounting dimensions for the fast loop reservoir.....	21
Figure 2.7: Hydraulic box with components indicated.....	22
Figure 2.8: Electronics enclosure.....	23
Figure 3.1: The dimensions for mounting the analyzer.....	25
Figure 3.2: Recommended complete system installation.	26
Figure 3.3: Electrical connections for user connections and power connections.	28
Figure 3.4: Mounting schematics for the reagent holding bracket.....	29
Figure 5.1: User interface main display screen.	31
Figure 5.2: User interface screen for Reagents Refill.....	33
Figure 5.3: User interface after pressing the RUN Menu.....	34
Figure 5.4: User interface in the DISPLAY Menu.	35
Figure 5.5: Manual step functions shown in the bottom left corner.....	36
Figure 5.6: Data logger screen of the user interface.	36
Figure 5.7: User interface after pressing the PROGRAM Menu.	37
Figure 5.8: The SETTINGS Menu and options are displayed.	37
Figure 5.9: User interface at the CALIBRATION Menu.	38
Figure 7.1: Pump tubing replacement.	46



LIST OF TABLES

Table 1.1: List of hazards and dangers.	11
Table 1.2: List of materials used in Waltron 3054 Analyzer.	12
Table 2.1: The run sequence of colorimetric determination.	18
Table 3.1: Terminal block pin locations.....	28
Table 5.1: User password.....	31
Table 5.2: Menu access level with password.....	31
Table 5.3: Analyzer operating statuses.	32
Table 5.4: Main menu button descriptions.....	32
Table 7.1: Scheduled maintenance reference chart.	45
Table 9.1: Alarm descriptions.	50
Table 10.1: Routine Maintenance Parts Listing.	51
Table 10.2: Standards and Reagents Parts Listing.....	51
Table 10.3: Spare Parts Listing.	51

1 OVERVIEW

1.1 SPECIFICATIONS

1.1.1 PERFORMANCE

Sensor Classification:	Colorimetric with glass flowcell and LED source
Application:	Demineralized, boiler, potable, surface and waste water
Power Supply:	110-220Vac, 50-60 Hz 80 VA
Humidity:	Up to 90% not condensable
Ambient Temperature Range:	10-45° C analyzer (50-113° F)
Range:	0 – 500ppb
Accuracy:	+/- 10 ppb or +/- 5% of full scale, whichever is greater
Unit Dimensions:	Height=23.6”(60 cm), Width=15”(38 cm), Depth=8.3”(21 cm)
Positioning and Installation Details:	Wall mounting or with bench support, panel mount optional
Response Time (approx.):	12min, batch process, programmable cycle frequency
Alarms:	2 or 4 configurable alarm relays
Reproducibility:	+/- 5% of reading
Degree of Protection:	IP55 (NEMA 4): Wet section, IP65 (NEMA 4x): Electronics
Required Maintenance:	Once a month replenish reagents, Quarterly tubing replacement
Reagent Consumption (approx.):	3 reagents, 1L each per month
Materials in Contact with Sample:	Glass, Silicone, Plexiglass, Stainless Steel AISI 316
CE Certification (on request):	Meets low voltage and low electromagnetic compatibility directives
Sample Conditioning Requirements:	Filtering between 10 and 60 micron, depending on the matrix, needed only to avoid clogging
Weight:	17 kg

1.1.2 SAMPLE OPERATING CONDITIONS

Temperature Range:	5-55° C (41-131° F)
Inlet Sample:	100–500 ml/min, atmospheric, flexible tubing O.D. ¼” (6 mm)
Outlet Sample:	Atmospheric, waste tubing O.D. 3/8” (9 mm)
Turbidity:	Not applicable, sample blank correction
Color:	Not applicable, sample blank correction
PH:	3-12

1.1.3 SIGNAL OUTPUTS

Analog Outputs:	4-20mA (galvanic isolator module available as option) or 0-5V
Serial I/O for Signals:	Serial data output RS232 standard, RS485 available as option

1.1.4 OPERATIONAL CALIBRATION

Single/Multi-Point:	Multi-Point: zero and mid-range
Matrix Corrections:	Yes, sample blank correction
Manual/Automatic:	Manual

1.2 SAFETY PRECAUTIONS, INSTRUCTIONS, AND HAZARDS

1.2.1 GENERAL INFORMATION

This manual contains important information which is required for installation, start up and operation of the Waltron 3054 Filming Amine Analyzer. Please read this manual carefully before installing and placing the analyzer into service!





Pay attention to all caution and danger labels present on the analyzer and all caution and danger statements written on this manual.

- The user has the responsibility to read and understand the information contained in this manual, and to abide by all applicable employee health and safety regulations.
- Use, maintenance, and service of this analyzer is allowed only by qualified personnel who are fully trained on the analyzer's operations. These personnel are required to be physically and mentally fit and not under the influence of alcohol or/and drugs.
- When the analyzer is not being used it should be protected by an appropriate circuit breaker. Failure to do so and non-observance of hazards or dangers warnings could result in death or serious injury to the operators or damage to the analyzer.
- Before using the analyzer, it is necessary to visually check for damage to safety devices and report issues to the appropriate responsible person, even if the analyzer continues to operate.
- The analyzer's components are installed inside a metallic enclosure with a door equipped with a special key, provided with the analyzer, to be used only by authorized personnel.

1.2.2 LIST OF WARNINGS AND POTENTIAL DANGERS

The table below is a list of hazard and danger warning labels that may be found on the analyzer and/or in this manual.

Table 1.1: List of hazards and dangers.

	<p>Hazard of electrical shock</p> <p>This symbol is used to present a hazard of severe electric shock or electrocution. All controls and maintenance on electrical devices labeled with this symbol should be made by qualified personnel in accordance with national or local regulations. Qualified Personnel means personnel who have been fully trained and have professional experience in avoiding electrical hazards and dangers. To avoid potentially fatal electric shock and/or analyzer damage always disconnect power to the analyzer before servicing.</p>	<p>Components:</p> <ul style="list-style-type: none"> · main power supply · peristaltic pump motor · input terminal · mixing pump · heater
	<p>Hazard of chemical burns</p> <p>This symbol is used to indicate the potential hazard of severe burns and serious injury due to hazardous chemicals. All handling of chemicals labeled with this symbol should be performed by qualified personnel in accordance with national or local regulations. Qualified Personnel means personnel who have been fully trained and have professional experience in avoiding chemical hazards and dangers. Before proceeding with the handling of chemicals and service operations, read the safety data sheets supplied with each chemical in order to take all the necessary precautions when handling, including appropriate personal protective equipment (PPE).</p>	<p>Components:</p> <ul style="list-style-type: none"> · fluidics section · reagent containers
	<p>Harmful</p> <p>Specific indication depending on the parameter analyzed and the chemical colorimetric method used.</p>	<p>Components:</p> <ul style="list-style-type: none"> · fluidics section · reagent container
	<p>Warning of general hazard</p> <p>Indication of general hazards or warnings to follow during installation, operation, or maintenance.</p>	

1.2.3 REAGENTS

The Waltron 3054 Filming Amine Analyzer operates based on standard colorimetric analysis methods, using chemical solutions.

- For the dangers and hazards regarding the chemicals used for the analysis, refer to the appendix or the supplied SDS sheets.
- Make sure that proper safety precautions are taken (e.g. using safety gloves and glasses) during handling the chemical solutions and the reagents containers / bottles.
- Read and understand the material safety data sheets for each chemical.
- The reagent bottles are marked with GHS compliant labels.

1.2.4 SAMPLE

Take the proper precautions to avoid direct contact with the sample stream. It is the responsibility of the user to take all necessary precautions regarding physical, chemical, radiation and/or biological hazards from sample stream and/or sample vapors. It is also the responsibility of the user to ensure the sample stream is compatible with the materials of construction listed below.

Table 1.2: List of materials used in Waltron 3054 Analyzer.

Pump tubing	Silicon or Norprene
Fittings	PP
Connection tubing	Norprene / Silicon
Colorimetric cell	Glass
Mixing membrane pump	PP / EPDM
Pinch valve	Viton / silicon tubing

1.2.5 WASTE DISPOSAL

The liquid waste from the analyzer contains small amounts of the reagent chemicals. Dispose of the waste in accordance with the appropriate regulations.

1.2.6 ANALYZER GENERAL HAZARDS

1.2.6.1 Electrical Hazards and Precautions

General information:

- In all electrical devices that are 110-220 Vac powered, there is a hazard of electrical shock or electrocution.
- To protect all personnel involved in analyzer use and maintenance, the door of the analyzer enclosure is equipped with a special key.
- Qualified service personnel will receive the special key to open the analyzer's enclosure.
- Before servicing the analyzer parts that are electrically powered, turn off power to the analyzer to avoid risk of electrocution.
- To turn off power from an electrical device, it is necessary to interrupt the power line using a circuit breaker or an isolating switch to be sure that there is no power in the area



- to be serviced.
- Inside the analyzer's enclosure, the lower level of protection against direct contacts is IP2X. The analyzer's enclosures are IP54. (NEMA 3)
 - Protection against indirect contacts is guaranteed by efficient grounding of all isolated metal masses. A grounding screw is located inside the electrical enclosure, in the lower right position.

1.2.6.2 Operating Hazards and Precautions

HAZARD Mechanical hazards caused by moving parts such as the peristaltic pump and the motor.

Preventive Actions:

To avoid risks, the analyzer's moving parts have been designed, built and located in a closed enclosure with a special key. Inside the enclosure, these parts have protective covers to avoid any contact and physical injuries to users.

HAZARD Hazard of burns and poisoning caused by contact with dangerous chemicals.

Preventive Actions:

To avoid risks, the analyzer's parts that can cause contact with chemicals have been designed, built and located in closed enclosure with a special opening key. Before servicing the liquids section, read the material safety data sheets supplied with each chemical and take all the necessary precautions when handling. Wear eye protection, gloves, mask and clothing if necessary.

HAZARD Hazardous fumes may be generated in the event of leaks in the reagent tubing.

Preventive Actions:

Install the analyzer in anadequately ventilated area.

HAZARD Hazard of electric shock and/or electrocution in the electrical enclosure.

Preventive Actions:

The analyzer's electrical equipment complies with EN 60204 (NEMA 3) standards. . To avoid risks, the analyzer's components that can cause electric shock and/or electrocution have been designed, built and located in an enclosure with a special key. Inside the enclosure, these parts have protective covers with warning labels to avoid contact and serious injuries or death to users.

NOTE: Electrical equipment with input power and grounding must comply with national and/or local regulations and laws.

Preventive Actions:

- Check that the source voltage to be used corresponds with that requested by the analyzer.
- Periodically check the power cord grounding in addition to the analyzer grounding.

2 INTRODUCTION

2.1 ANALYZER DESCRIPTION

The Waltron 3054 is an on-line analyzer for batch analysis (sequence of sampling, analysis and result processing), using a colorimetric method. The analyzer is assembled in an enclosure with a lockable door. The LIQUIDS enclosure includes all the components involved in sample and reagent flows as well as mixing and reaction stages (sampling pump, colorimetric reaction cell, reagent micropumps). The ELECTRICAL enclosure includes the main power supply, the controller PCB assembly, and the touchscreen interface.



Figure 2.1: Waltron 3054 Analyzer front view.

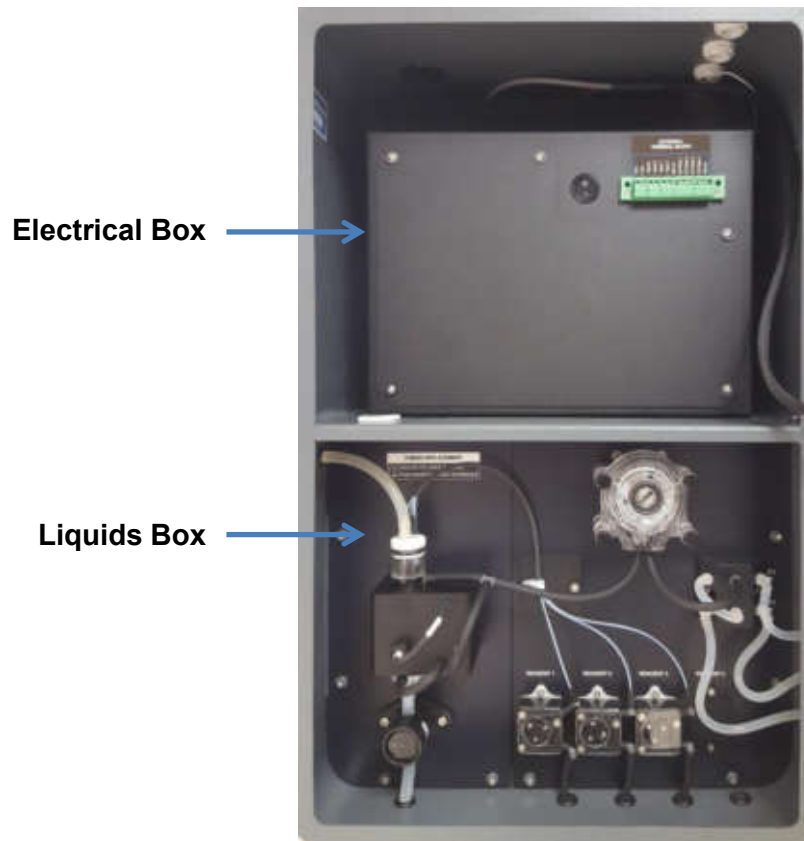

Figure 2.2: Waltron 3054 inside view with electrical box and liquids box shown.

2.2 APPLICATIONS

The Waltron 3054 Analyzer is designed for measurement of Filming Amine concentrations in high purity water.

2.3 WORKING PRINCIPLE

Lambert-Beer Law

A colorimetric determination is based on the color-formation after addition of reagents. The absorbance of the solution is measured at a specific wavelength. The absorbance is related to sample concentration according to 'Beer's law'.

The Lambert–Beer law is an empirical relationship that relates the absorption of light to the properties of the material through which the light is travelling.

The law states that there is a logarithmic dependence between the transmission (or transmissivity), T , of light through a substance and the product of the absorption coefficient of the substance, α , and the distance the light travels through the material (i.e. the path length), ℓ .

The transmission (or transmissivity) is expressed: $T = I_1 / I_0$

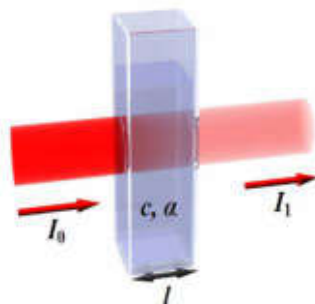

Absorbance for liquids is defined as the negative logarithm of the transmittance:

$$A = -\log_{10} T = \log_{10} 1/T = \log_{10} I_0/I_1$$

I_0 = light intensity through the sample before colorimetric reaction

I_1 = light intensity through the sample after colorimetric reaction

In most cases the absorbance has a linear correlation with the sample concentration; for a linear calibration line just the blank and span values (i.e. concentration with zero analyte and the maximum expected concentration) are needed. Multiple analyses at each point are averaged to provide a more accurate calibration line.

The absorbance ranges from 0 to 1, but it can go higher.

- An absorbance of 0 at some wavelength means that no light of that particular wavelength has been absorbed. The intensities of the sample and reference beam are both the same, so the ratio I_0/I_1 is 1. \log_{10} of 1 is zero.
- An absorbance of 1 occurs when 90% of the light at that wavelength has been absorbed which means that the intensity is 10% of the blank value. In that case, I_0/I_1 is 100/10 (=10) and \log_{10} of 10 is 1.

Absorption photometry (Colorimetry):

The method used is based on the formation of a colored complex of the analyte with a reagent. Light with a specific wavelength is passed through the sample and reagent solution. The absorbance of this light by the reaction complex, measured by a photometer, is related to the concentration of the analyte.

$$\text{Absorbance} = \log \frac{\text{reference}}{\text{sensor reading}}$$

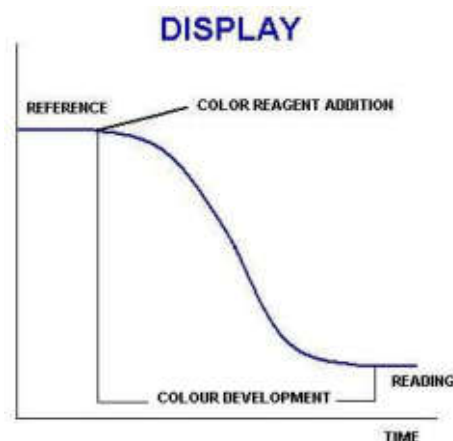

Figure 2.3: Color development.

2.4 ANALYSIS CYCLE

2.4.1 PROGRAMMING COMMANDS

An analysis time program in the Waltron 3054 Filming Amine Analyzer has the following structure:

1. After rinsing the reaction colorimetric cell and taking a sample, one of the reagents (R1) is added and mixed after which a reference measurement is taken. In this way interfering factors are eliminated such as sample color or turbidity, reagent color, or refractive index variations.
2. The actual Filming Amine reading is taken after addition of the color forming reagent (R2) and color development.
3. After the Filming Amine reading is taken, the colorimetric cell is drained and refilled, and a cleaning solution (R3) is added, mixed, drained, and flushed to remove any traces of the color reaction product from the cell.

Table 2.1: The run sequence of colorimetric determination.

Conditioning, rinsing and sampling <i>Drain, rinse and sample functions</i>	The colorimeter cell is drained and refilled with sample 3 times, and then filled and left full of sample. This clears the sampling pump, tubing, and cell and insures a fresh sample is analyzed.
Addition of reagent(s) <i>Add reagent function</i>	Following the addition of Reagent 1, the mixing pump is activated and the liquid is pumped from the lower part to the upper part of the colorimetric cell. The waiting time is programmed in order to eliminate bubbles and suspensions.
First measurement <i>Reference function</i>	A reading is taken using the colorimeter to provide a reference value to compare the measured color against. This automatically corrects for sample background color or turbidity.
Addition of color reagent(s) <i>Add reagent function</i>	Reagent 2 is added to form the color.
Mixing and wait <i>Mix and wait functions</i>	The mixing pump is activated and the liquid is pumped from the lower part to the upper part of the colorimetric cell; in this way reagent(s) is mixed. The waiting time is programmed in order to complete the colorimetric reaction.
Reading, absorbance and concentration calculation <i>Read sensor, absorbance, calculation</i>	Reading of the light intensity after the colorimetric reaction, calculation of the absorbance and of the concentration.
Drain, rinsing, sampling <i>Drain, rinse and sample functions</i>	Drain and rinse of the hydraulic line and the colorimetric cell.
Cleaning, rinsing, sampling <i>Clean, rinse, and refill</i>	Reagent 3 is added, the mixing pump is activated to clean the cell, then the cell is drained and refilled with sample for the programmed waiting period
Waiting time (analysis frequency)	The wait function is a programmable time the user can use to determine sample and analysis frequency.

Wait function	
---------------	--

2.4.2 FLOW DIAGRAM

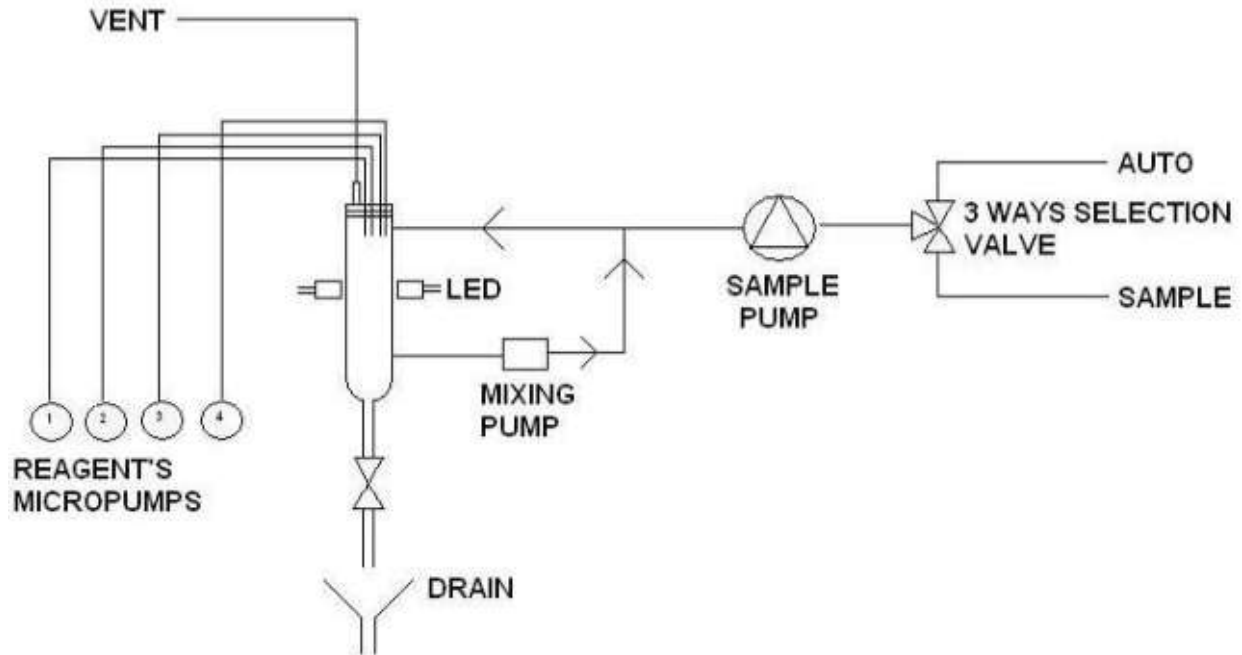

Figure 2.4: Flow diagram

2.4.3 ANALYZER OPERATIONS

The Waltron 3054 Filming Amine Analyzer performs several operations throughout a cycle. A list of common operations is shown below.

- Rinse #1
- Rinse #2
- Drain
- Sample #1
- Sample #2
- Add Reagent #1
- Add Reagent #2
- Add Reagent #3

2.5 FAST LOOP RESERVOIR

The fast-loop reservoir, required for online applications, allows continuous flow of the sample from the sampling point. Inside the fast-loop reservoir the sample is at atmospheric pressure and this allows the sample pump to provide the analyzer with a constant delivery of sample with no overpressure. In addition, the fast-loop reservoir holds additional sample to avoid false alarms in case of brief loss of sample as well as to remove air bubbles that may be present in the sample line.

- The stainless steel drain tubing maintains a constant water level inside the reservoir and allows for proper sample circulation to avoid accumulation of suspended solids..
- The sample flow should be adjusted to allow continuous sample overflow to waste through the U-shaped stainless steel tube. Inside the reservoir a level sensor checks for sample presence. If sample flow is lost, the level switch will place the analyzer in standby mode. When sample flow resumes and level is detected in the reservoir, the analyzer will start automatically with a new cycle.
- Connect the cable from the fast-loop reservoir to the level switch connector on the right-hand side of the instrument case, near the top.

NOTE:

In the case of dual stream units, there will be two separate fast loop reservoirs, one for each of the sample streams.

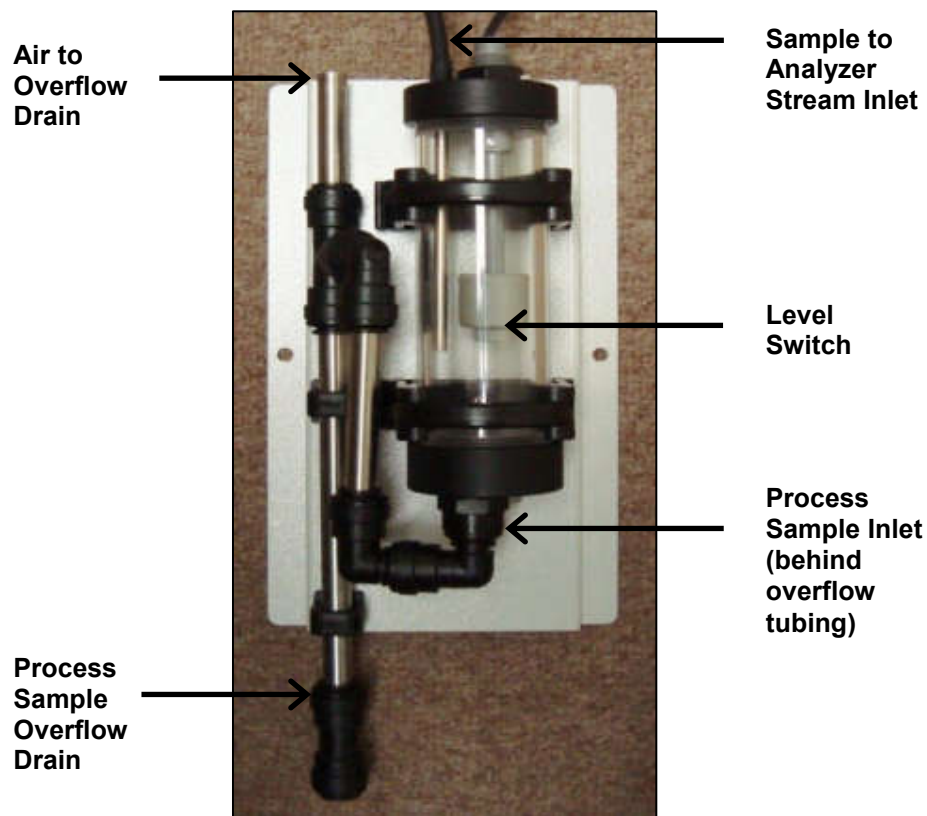

Figure 2.5: Depiction of the fast-loop reservoir.

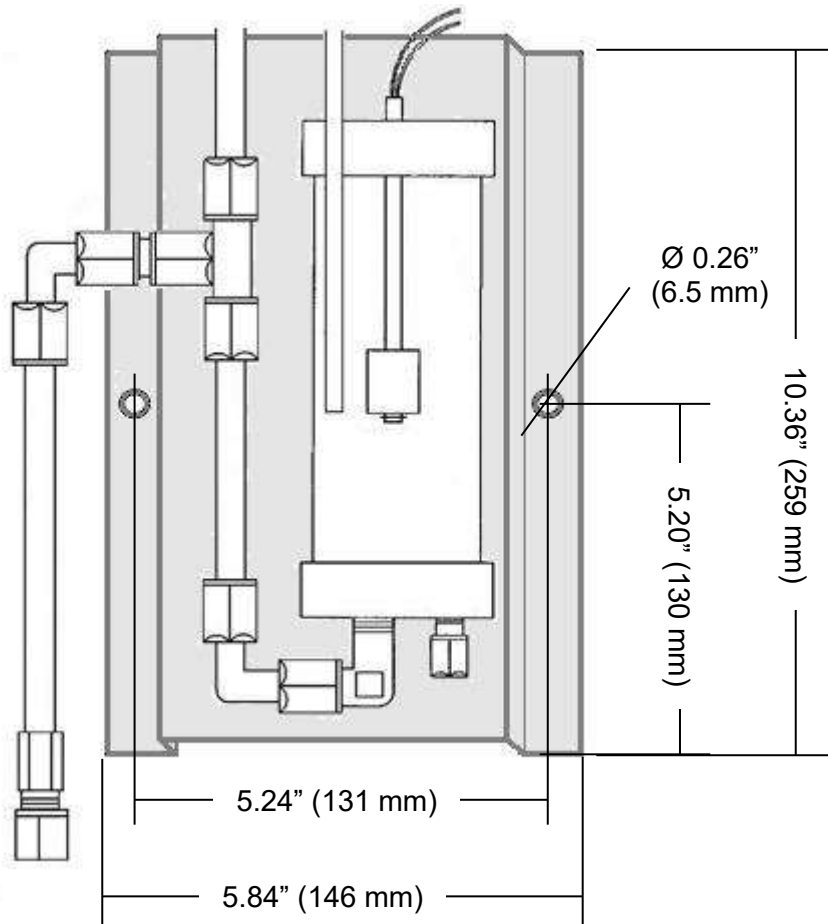

Figure 2.6: Mounting dimensions for the fast loop reservoir.

2.6 WET-SECTION BOX

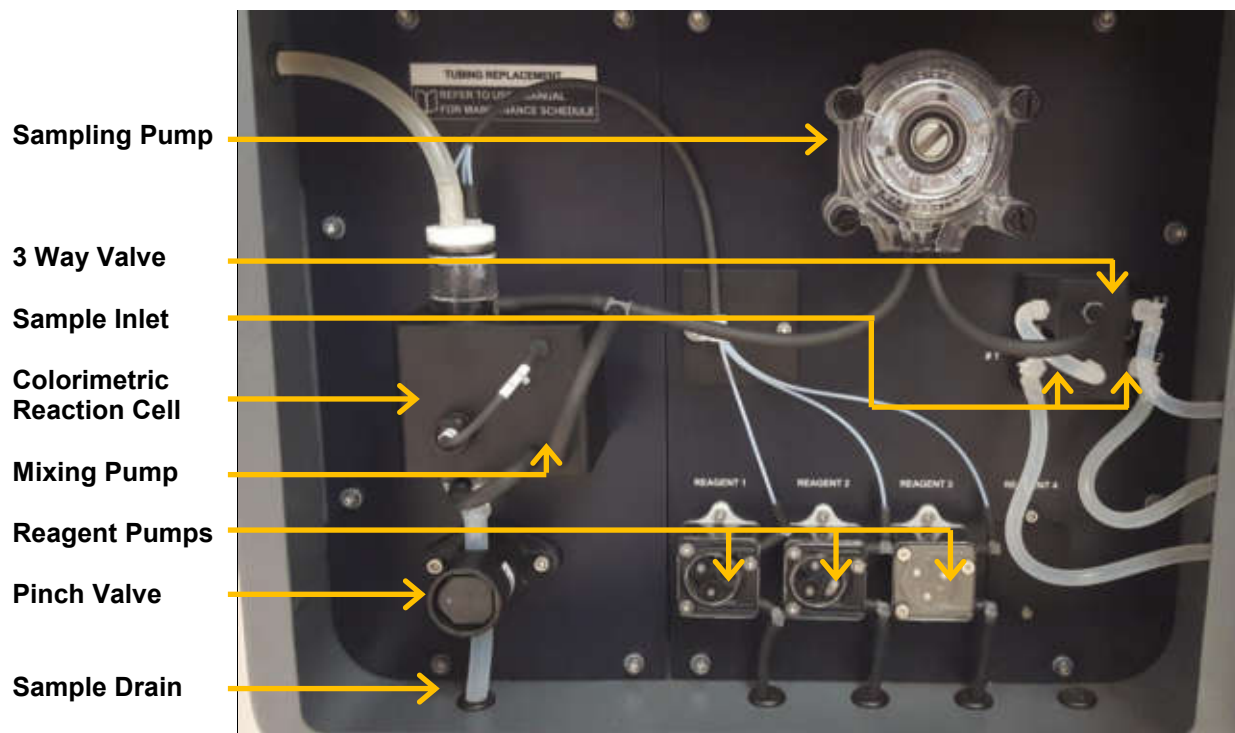

Figure 2.7: Hydraulic box with components indicated.

Sampling Pump

The analyzer uses a peristaltic pump for sampling. Pump tubing must have the proper diameter suitable for the pump. The diameter and the material of the tubing is very important; use only Waltron spare parts.

3 Way Valve

Allows the analyzer to choose between Sample Inlet 1, Sample Inlet 2 (dual stream units only), and Calibration Standard Inlet for analysis.

Sample Inlet

The tubing for the sample inlet(s) and calibration standard inlet pass through the housing enclosure on the right hand side of the unit and are connected to the 3 way valve.

Colorimetric Reaction Cell

The colorimetric reaction cell is made of glass; the diameter is 16 or 25 mm, depending on the parameter. The cell is positioned inside a thermostated block fixed with 2 screws. The block can be easily removed to allow the cleaning of the glass cell.

Reagent Pumps

The reagents are dosed with peristaltic pumps. The 3054 has three reagent pumps.

Pinch Valve

Normally-closed pinch valve to pinch or open the drain tubing in order to close or open the drain of the colorimetric cell. The size and the material of the tubing is very important; use only Waltron spare parts.

Mixing Pump

The sample is mixed with reagents with a membrane mixing pump. The liquid is pumped from the lower part to the upper part of the colorimetric cell.

Sample Drain

The tubing for the sample drain maintains a constant level of few cm of liquid on the colorimetric cell.

2.7 ELECTRONICS

The microprocessor and its PCB assembly are located in the electronic section. It provides control for the entire analyzing system. It handles the analyzer operations, collects all the data, and it controls all the I/O to and from the HMI touchscreen, and the instrument outputs to external devices. The connections for the external terminal block are shown in Section 3.6.2.

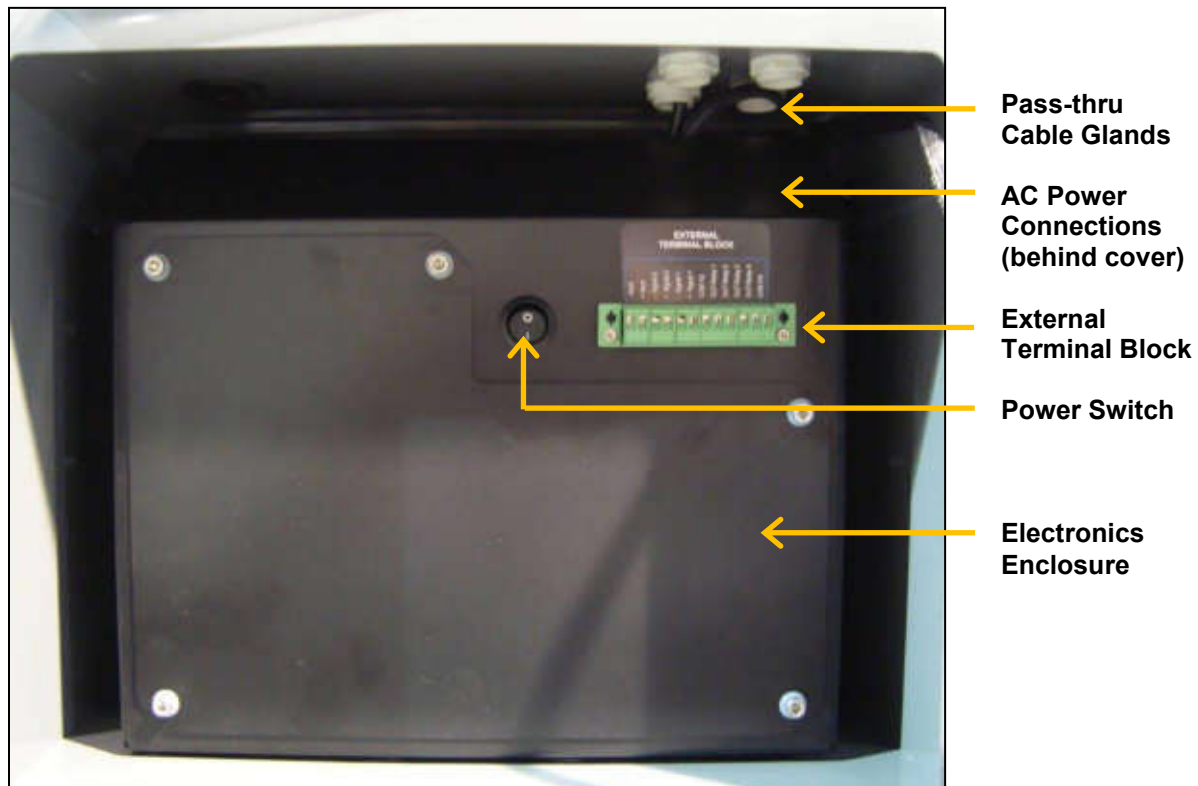

Figure 2.8: Electronics enclosure.

3 INSTALLATION

3.1 RECEIVING

The Waltron 3054 Filming Amine Analyzer is assembled and fully tested for proper performance. Before proceeding with analyzer installation, it is recommended to:

- Check that the box and analyzer have not been damaged during transportation.
- Take extreme care during analyzer unpacking and moving.
- Be careful not to misplace accessories during unpacking. Refer to the included packing list.

3.2 ANALYZER HANDLING

Take care when lifting or moving the analyzer. Before moving the analyzer, it is recommended to manually empty all of the hydraulic parts of any liquids.

3.3 LOCATION AND MOUNTING

It is recommended to install the analyzer in a suitable location::

- The location is to be clean, covered and properly enclosed to provide the analyzer with good ventilation and low dust concentration.
- Required environmental conditions:
 - Temperature between 10 and 45°C (50-113F) at max 80% relative humidity. If the temperature could fall below 5°C, the analyzer should be installed in a heated cabinet.
- Because of chemicals and waste gases it is necessary to have a well ventilated location for the analyzer.
- The analyzer is supplied with four mounting brackets for wall or stainless steel support rack installation. Use 4 screws M6 or M8 (1/4") to mount the analyzer. A panel mounting kit is available from Waltron if desired.
- Reagent bottles are supplied with the analyzer.
 - A reagent shelf is provided with the instrument
 - Allow a minimum of 14 inches (40 cm), but no more than 30 inches (75 cm), below the analyzer for the reagent bottles.
- The fast-loop reservoir should be mounted within reach of the sample tubing (approximately 24" (60 cm) in length).

3.4 PRE-INSTALLATION

Before installing the analyzer, take the following precautions:

- Place the analyzer close to the sample point to achieve the minimum response time; the sample should be homogenous and representative.
- The drain line should be properly dimensioned and positioned at a downward slope to allow the drain of analyzed sample (by gravity) and the overflow coming from external fast-loop reservoir (if used).

WARNING!

The sample drain of the analyzer must be at ambient pressure with no restriction or counter pressure. Please verify that this condition has been strictly respected during installation.

- Clearance requirements for the analyzer should be about 8" (20 cm) on either side and about 40" (100 cm) in the front.
- Sufficient space for the reagent containers should be provided on the side or beneath the analyzer.
- The reagent containers should be positioned in the reagent bracket or a suitable basin in case of spills.

NOTE:

Respect the maximum height of 16" (40 cm) between the reagent's bottle(s) and the reagent's pump(s).

3.5 MOUNTING SCHEMATICS

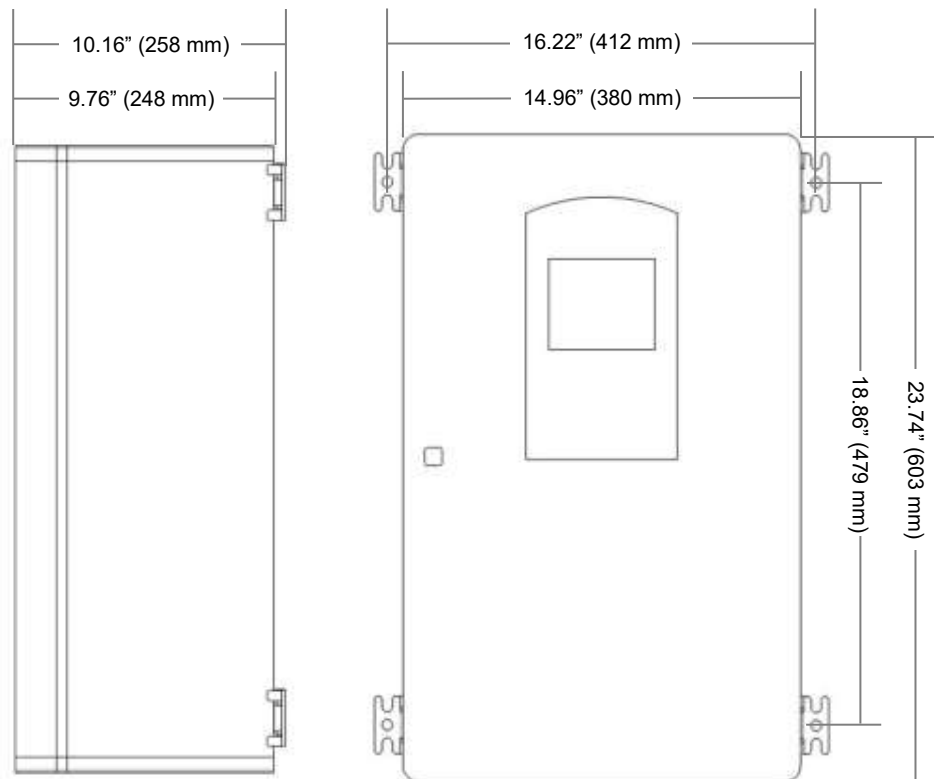

Figure 3.1: The dimensions for mounting the analyzer.

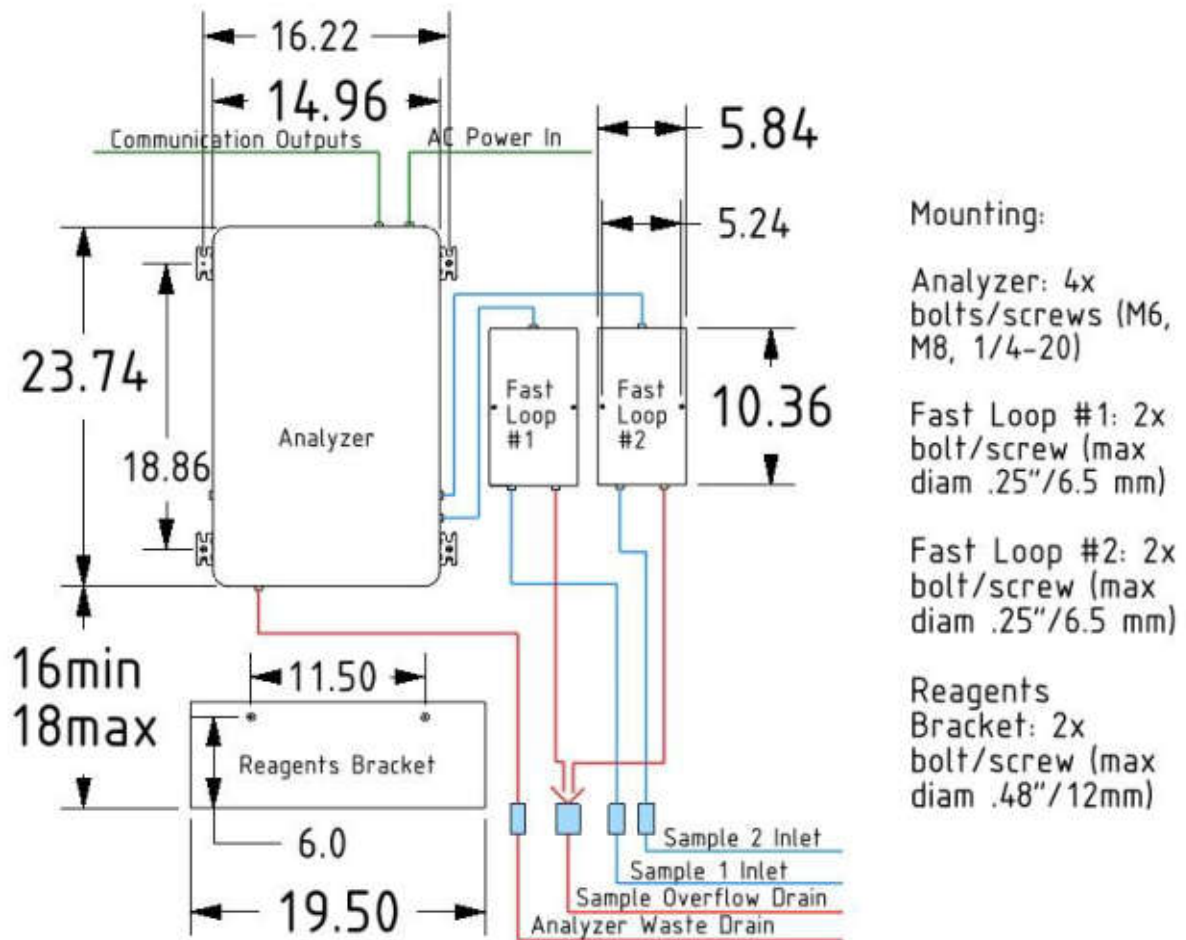

Figure 3.2: Recommended complete system installation.

Note: Single channel analyzers will only have one Fast Loop Reservoir.

3.6 ELECTRICAL CONNECTIONS

General information:

- The electrical installation should be carried out by qualified personnel in accordance with national or local regulations.
- Qualified service personnel will receive the special key to open the analyzer's enclosure.
- Before servicing the analyzer or its parts that are electrically powered, turn off power to avoid risks of electrocution.
- To turn off power from an electrical device, it is necessary to interrupt the power line using a circuit breaker or an isolating switch to be sure that there is no power in the area to be serviced.
- Protection against indirect contacts is guaranteed by efficient grounding of all isolated metal masses.
 - Grounding screw is located in the upper left position inside the electrical enclosure.
 - The user is responsible for checking and guaranteeing the efficiency of the analyzer's grounding.

Users and qualified maintenance personnel must proceed as follows:

- Be aware of electrical shock and/or electrocution labels placed on the analyzer.
- Always isolate power before servicing the analyzer.

In case of loss of power, the analyzer stops and automatically restarts into standby mode as soon as power is restored.



No maintenance should be conducted on the instrument without first switching off the power.

3.6.1 AC POWER CONNECTION

The Waltron 3054 Filming Amine Analyzer is designed for operation with 110-220Vac, 50/60 Hz power. All the connections must be made in accordance with national or local regulations. The analyzer is equipped with a main power switch. It is always recommended that the analyzer is connected to the main via a circuit breaker or an isolating switch installed near the unit.

To make changes to the AC power connections, it is necessary to remove the electronics enclosure cover. The AC power connections are fed to a connector that sends the power to the ON / OFF switch before reaching the analyzer. The connections are shown below in Figure 3.2.

3.6.2 USER SIGNAL CONNECTIONS

The analyzer provides an External Terminal Block on the outside of the Electronics Enclosure. It allows the operator to connect to an external device such as a sequencer or sampler, monitor the 4-20mA outputs and monitor alarm relays. The external terminal block can be configured from the SERVICE Screen.

Table 3.1 below shows the terminal contact labels starting with pin 1 on the left.

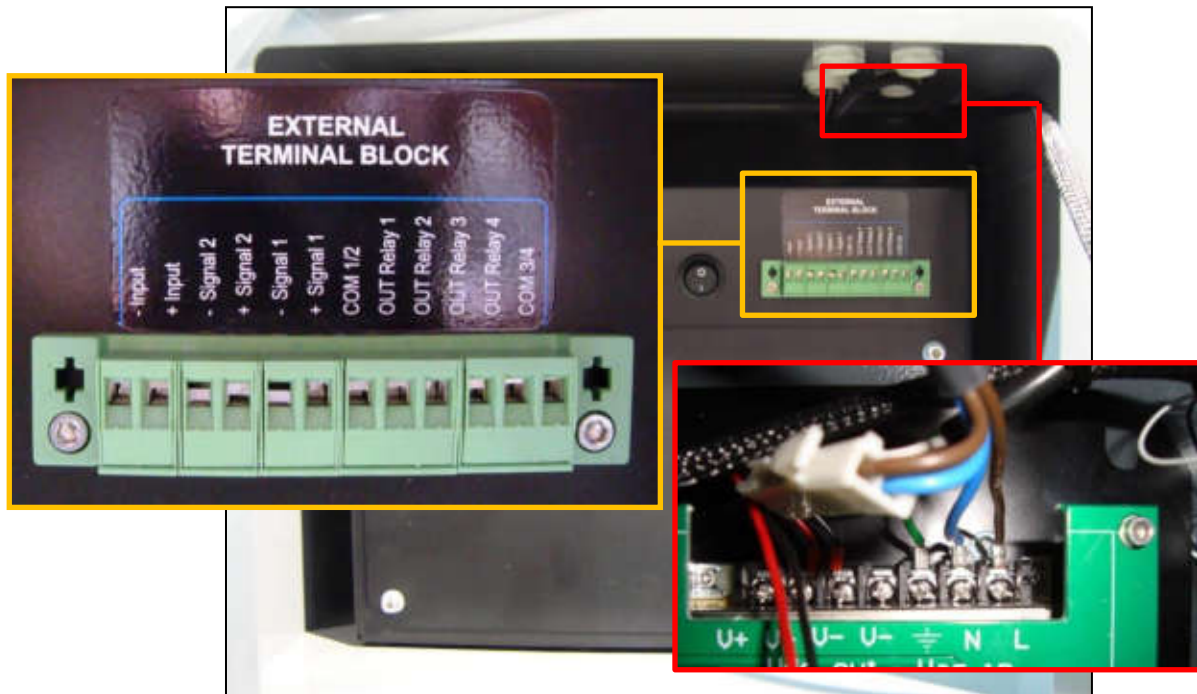

Figure 3.3: Electrical connections for user connections and power connections.

Table 3.1: Terminal block pin locations.

Pin Number	Terminal Label	Description
1	- Input	NO contact from an External Device to tell the analyzer to take a measurement.
2	+ Input	
3	- Signal 2	4-20mA output for Sample 2 Measurement
4	+ Signal 2	
5	- Signal 1	4-20mA output for Sample 1 Measurement
6	+ Signal 1	
7	COM 1/2	Common for Relay 1 and 2
8	OUT Relay 1	Alarm Relay 1 N/O Contacts
9	OUT Relay 2	Alarm Relay 2 N/O Contacts
10	OUT Relay 3	Alarm Relay 3 N/O Contacts
11	OUT Relay 4	Alarm Relay 4 N/O Contacts
12	COM 3/4	Common for Relay 3 and 4

3.7 REAGENT INFORMATION

The Waltron 3054 Filming Amine Analyzer uses 3 reagents for the colorimetric measurement.

- Reagent 1: Buffer Solution
- Reagent 2: Indicator Solution
- Reagent 3: Cleaning Solution

3.8 REAGENT HOLDING BRACKET

Use the drawing below to mount the reagent bracket below the analyzer.

NOTE:

Mount the bracket below the analyzer so that the base of the bracket is at least 14 inches (40 cm) below the analyzer, but no more than 30 inches (75 cm) below the analyzer. If space is limited, the reagent shelf can be mounted to either side of the analyzer up to the limit of the tubing length from the pumps.

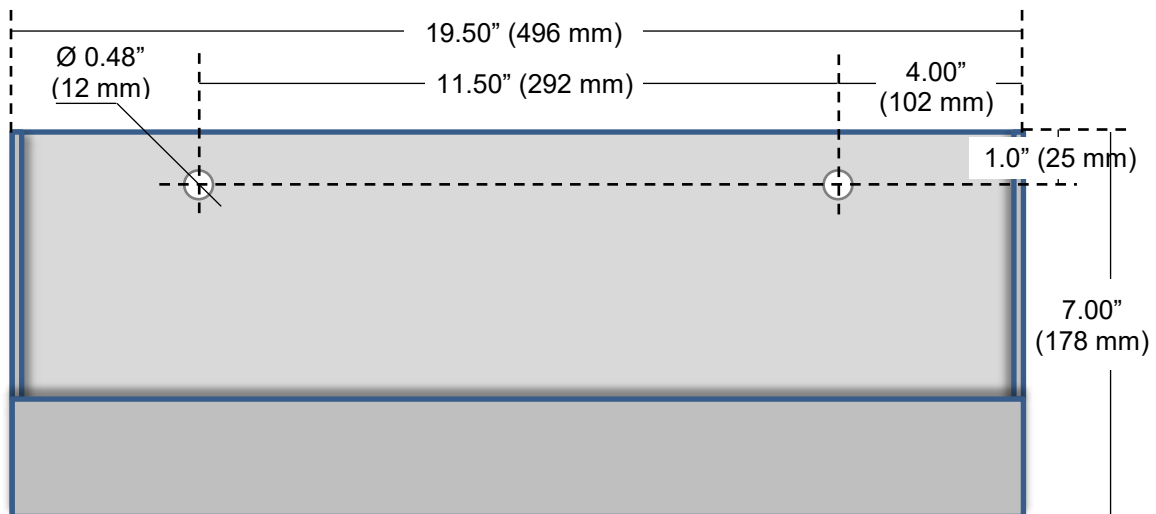

Figure 3.4: Mounting schematics for the reagent holding bracket.

4 ANALYZER INITIAL START-UP



Before proceeding with analyzer start-up it is absolutely necessary to check that all procedures for a proper installation and reagent preparation have been made. Please verify that all instructions have been followed.

4.1 PREPARING THE ANALYZER FOR START-UP

Once installation is complete, proceed as follows to prepare the analyzer for online operation :

1. Connect the sample line inlet tubing (or filtered sample outlet coming from optional filtration system) to the fast-loop reservoir using the bottom connection on the reservoir. Then connect the analyzer sample tubing to the top connection on the reservoir.
2. Connect the analyzer sample tubing as follows:
 - a. For single channel analyzers, connect the sample to connection #1 on the inlet block, and the standard to connection # 2.
 - b. For dual channel instruments, connect sample #1 to connection #1, sample #2 to connection #2, and the standard to connection #3.
3. Connect the drain fitting of the fast-loop reservoir(s) to the waste line
4. Put the reagent inlet tubing into the appropriate reagent containers
 - a. Reagent 1
 - b. Reagent 2
 - c. Reagent 3
5. Connect the analyzer drain tubing to the waste drain line

WARNING!

The drain of the analyzer must be at ambient pressure with no restriction. Please verify that this condition has been strictly followed during initial start-up procedures.

6. Adjust sample flow to the fast loop reservoirs to 100-500 ml/min.
7. Turn the analyzer on using the switch in the electronics compartment
8. Perform reagents prime (see Section 6.1)
9. Perform calibration (see Section 6.2 & 6.3)
10. Set the analyzer to online mode (see Section 6.5)

5 USER INTERFACE

5.1 USER INSTRUCTIONS

The user's interface consists of the touchscreen located on the front panel of the analyzer enclosure. All the input/output data, information, alarms and fault conditions are shown on the display while all the commands and settings may be transferred to the analyzer simply pressing the touchscreen buttons.

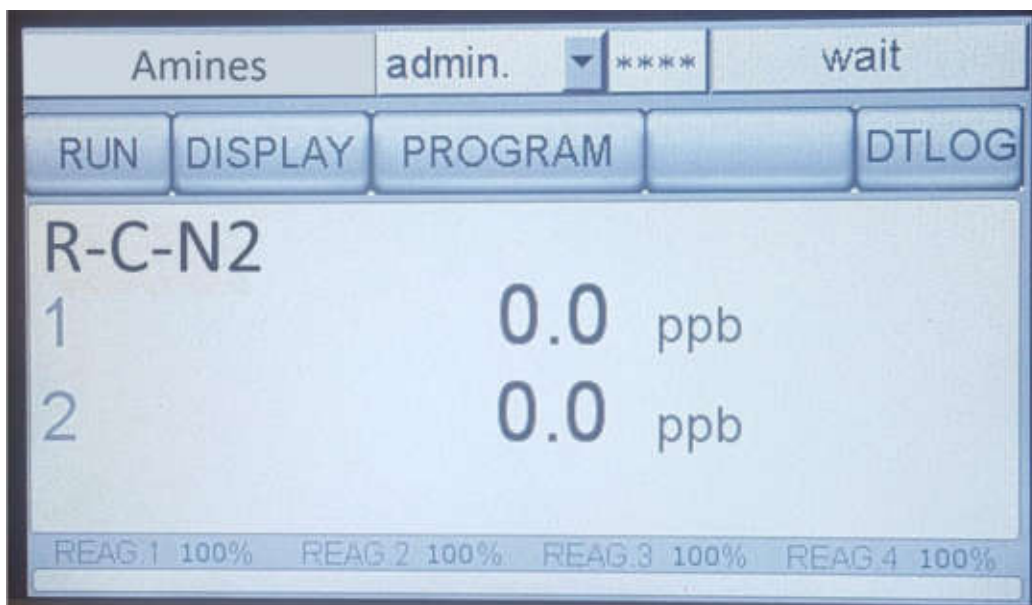

Figure 5.1: User interface main display screen.

5.2 USER PASSWORD

Table 5.1: User password.

First Level Password (service)	1111
Second Level Password (admin.)	Contact Waltron

Table 5.2 shows the menus and sub-menus that are available based on which level of password is input.

Table 5.2: Menu access level with password.

No Password	Service Password	Admin. Password
Main Menu	Display Menu – Manual Step	Program Menu – Analysis Cycle
Display Menu – Display process values	Program Menu – Calibration Menu	Program Menu – Extra Cycle
Program Menu – Settings		Service Menu
Data Log		

5.3 MAIN SCREEN

The main screen displays:

- Name of the analysis program (Filming Amine Analyzer)
- Login **** window (two levels of password); pressing on **** the user can input the 4 number password
- Buttons that allow access the sub-menus (Run, Display, Program, Service and ?)
- Value (ppm or ppb) of the last analysis
- Alarms / relays
- Active step of the analysis in progress
- Reagent(s) consumption (%)

Table 5.3: Analyzer operating statuses.

ANALYZER OPERATING STATUS	
STAND-BY	The analyzer is waiting for a user's command (for example when the analyzer is switched on after a shutdown), after single cycle analysis, or when the operator has forced a stop to stand-by at the end of the current online / single cycle by pressing the button previously activated a second time.
SINGLE CYCLE	The analyzer is performing a single analysis cycle. As soon as the cycle is completed the analyzer will go into the stand-by condition.
ON-LINE	The analyzer is performing a continuous cyclic analysis based on the steps set in the PROGRAM menu (Analysis Cycle) and started when the START ON LINE button has been pressed. As soon as the analyzer completes an analysis cycle, it will restart with a new analysis. This condition is identified as the online condition.
MANUAL STOP	The analyzer has been forced to stop. A message in the main menu shows the "manual stop" and the fault alarm is initialized.

Table 5.4: Main menu button descriptions.

MAIN MENU BUTTONS	
RUN	This menu allows the user to put the analyzer into online measurement mode or run a single analysis cycle on stream 1 or stream 2. The user can also stop the analyzer with the emergency stop button.
DISPLAY	This menu displays all analysis data, the active step of the current analysis cycle with the time counter, the sensor's signal trend graph, and allows access to the manual step functions.
PROGRAM	First level service password required. This menu allows access to the calibration menu, enabling and disabling the loss of sample alarm, enabling the 4-20 mA output, and settings of the analyzer.
SERVICE	Second level admin password required. This menu allows access to the analysis parameter, time, blank value, and configuration of the 4-20 mA output, led light source, and reference value.
DATA LOG	This menu shows the data log.

5.4 REAGENT REFILL

The remaining reagent is shown as a percent (%) at the bottom of the main display screen.

If the reagent level falls below a value of 4%, the analyzer goes into FAULT status and stops automatically. The alarm message will be displayed in the main menu and the FAULT contact will be activated.

Every time the reagents are refilled, it is necessary to reset the value to 100%.

1. Press on the value % of each displayed reagent.
2. Bottle Reag. 1,2,3 Filled? YES.

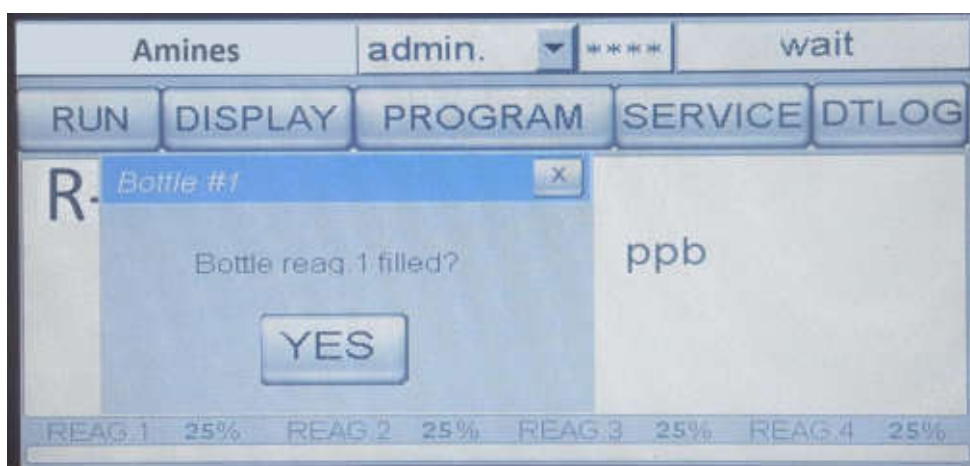

Figure 5.2: User interface screen for Reagents Refill.

5.5 RUN MENU



Figure 5.3: User interface after pressing the RUN Menu.

START ON-LINE:

This button puts the analyzer into continuous online operation. The analyzer will perform a continuous cyclic analysis based on the steps set in the PROGRAM menu (Analysis Cycle). This condition is identified as online and ONLINE is displayed on the button. Pressing the button again will cause the analyzer to finish the cycle in progress and put the analyzer in stand-by mode.

CH 1:

This command will perform a single analysis cycle on stream 1. At the end of the cycle, the analyzer will go into stand-by mode and wait for the user's next command.

CH 2 (available on dual stream units only):

This command will perform a single analysis cycle on stream 2. At the end of the cycle, the analyzer will go into stand-by mode and wait for the user's next command.

EXTRA:

This command will perform a cycle based on the programming of the extra cycle. The default programming for the extra cycle is set to a CALIBRATION cycle.

EMERGENCY STOP:

This command will immediately stop the analyzer at the current step of the analysis in progress. The analyzer will go into the MANUAL STOP condition. On the main screen appear the message "manual stop" red coloured and the FAULT alarm contact will be activated. To restart the analyzer after an emergency stop, it is necessary to reset the fault by pressing the yellow colored RESET EM. STOP. This will force the analyzer to stand-by conditions.

5.6 DISPLAY MENU

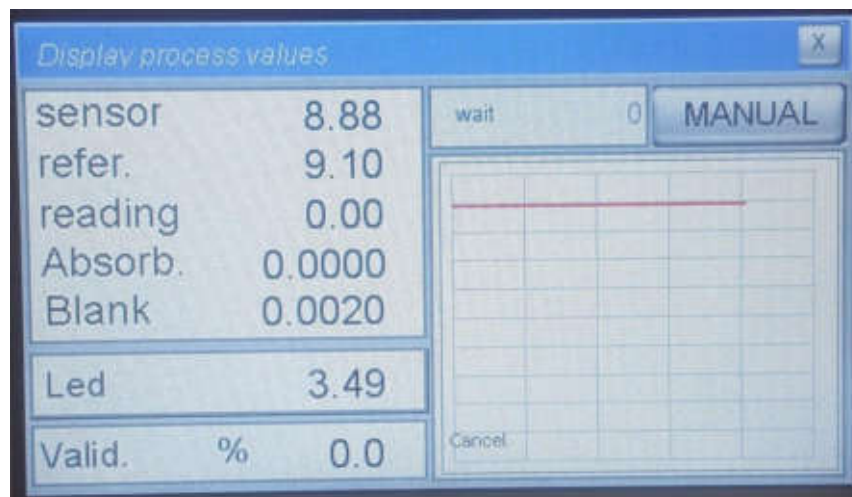

Figure 5.4: User interface in the DISPLAY Menu.

5.6.1 DISPLAY PROCESS VALUES

The following is a list of the data displayed in this menu (read-only values):

- **Sensor** : shows the current measurement of the sensor
- **Refer.:** shows the reference value (first point for the absorbance calculation)
- **Reading:** shows the reading of the sensor (second point for absorbance calculation)
- **Absorb.:** displays the last absorbance value calculated
- **Blank** : shows the most recent blank value
- **Led:** shows the led supplied
- **Valid. %:** it shows the validation value in %, compared to the calibration value
- **Current operation:** this window displays the current analysis step and the time in progress (countdown for every step programmed)

5.6.2 CHART

It displays in a graphic the sensor's signal trend during the current analysis cycle.

5.6.3 MANUAL STEP

This button allows to access to the manual commands of each programming step (see list in Section 2.4.1) individually. The operator can determine which single operation to run (select function) and the elapsed time for the operation in seconds.

This function is available only when the analyzer is in stand-by mode.

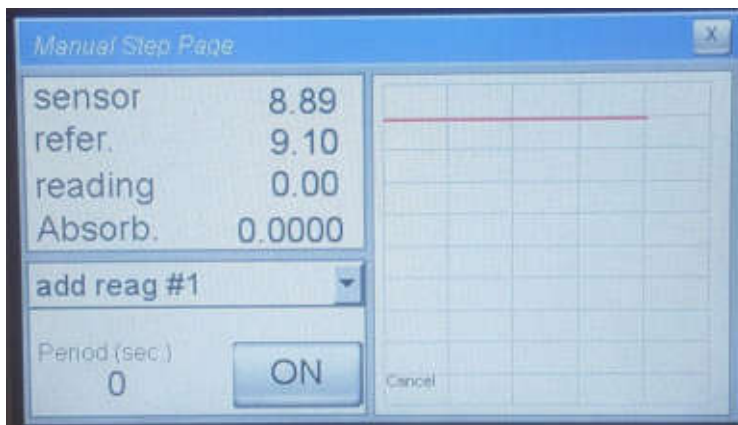

Figure 5.5: Manual step functions shown in the bottom left corner.

5.7 DATA LOGGER

From the main screen, pressing the Data Logger button in the upper right hand corner will display the previous 500 results, organized by date. Selecting the drop down menu at the top will provide options to view results from any date that results were logged. Pressing the Erase button will erase all results in memory.

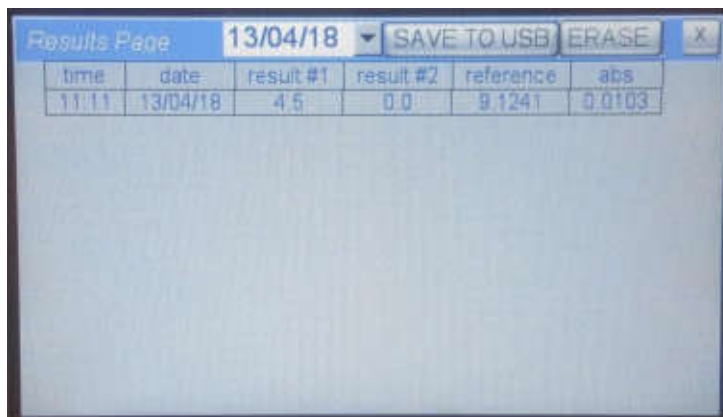

Figure 5.6: Data logger screen of the user interface.

5.7.1 SAVE TO USB

To export the stored results in the data log to a csv file:

1. Insert a USB memory stick into the bottom of the touchscreen display.
2. An action menu will appear on the display; press cancel to exit the menu.
3. Access the data log by pressing the DTLG button on the main screen.
4. Press and hold the 'Save to USB' button at the top of the data log.
5. A status circle should appear. After the button has been held down for a few seconds, the status circle will disappear, indicating that the results have been downloaded.
6. Remove the USB memory stick from the touchscreen.

5.8 PROGRAM MENU

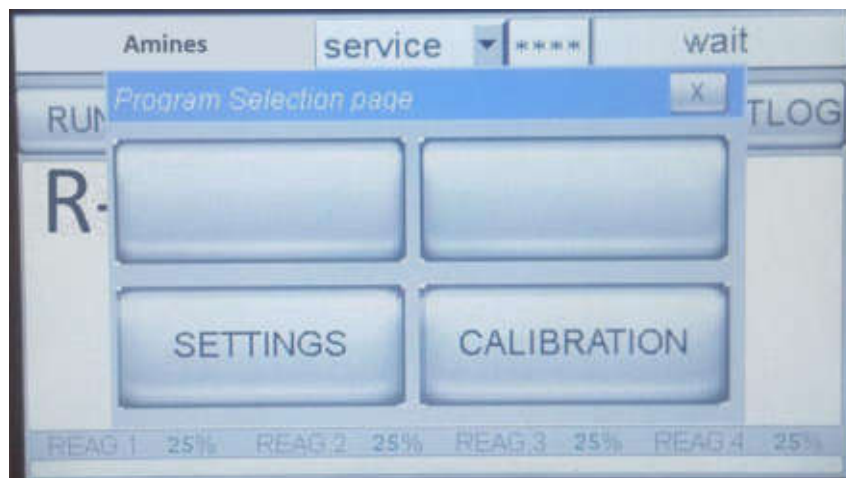

Figure 5.7: User interface after pressing the PROGRAM Menu.

The PROGRAM Menu allows access to the following operations:

SETTINGS:

Allows the user to set the ratio of the analysis cycles versus the extra cycles, the alarm value (low or high) and to enable or disable the loss of sample alarm and the 4-20 mA output.

CALIBRATION MENU:

This function is protected with the 1st level of password. Allows the user to set the value of the standard used for calibration and to perform blank and calibration cycles.

5.8.1 SETTINGS MENU



Figure 5.8: The SETTINGS Menu and options are displayed.

Cycles ratio: Programs the ratio of the analysis cycles versus the extra cycle (calibration cycle). For example, 400 analysis to 1 extra cycle means that every 400 analysis cycles the analyzer will perform 1 calibration cycle.

Cycle wait: Sets the time between analysis cycles when the analyzer is in on-line mode.

Result alarm: Programs the low / high value alarm. The alarm is expressed in % of full scale.

Output Signal: Enables / disables the 4-20 mA output.

Datalog: Enables / disables the internal data logger.

Sample Alarm: Enables / disables the loss of sample alarm.

5.8.2 CALIBRATION MENU

Allows the user to display and set the value of the standard used for calibration and perform manual blank and calibration cycles (refer to Section 6).



Figure 5.9: User interface at the CALIBRATION Menu.



5.9 SERVICE MENU

Access to the SERVICE Menu requires the second level password for the admin login. The SERVICE Menu allows the user to configure the external terminal block connections.

Configure the External Control

On the Service screen change the External Input selection from NONE to either ONLINE or EXTRA CYCLE (i.e., Calibration). This can be used to start the analyzer from an external device (example: start the analyzer whenever a system valve is opened or a pump is started)

Setting the range for the 4-20mA Sample 1 Output

Set the range of the 4-20mA Sample 1 Output with the F Scale1 selection. The default range is equal to the range of the analyzer. This is used to scale the instrument output to the scale of the external datalogger or recorder.

Setting the range for the 4-20mA Sample 2 Output

Set the range of the 4-20mA Sample 2 Output with the F Scale2 selection. The default range is equal to the range of the analyzer. This setting only applies to dual stream analyzers.

Configuring Relay 1, 2, 3 and 4

There are 4 cells on the service screen to configure Relay 1, Relay 2, Relay 3 and Relay 4. Touch one of these cells and select the parameter to activate the relay:

Result Alarm – The measurement is greater than the % specified on the Settings screen. For example: If the Result Alarm on the Settings screen is set to greater than 50%, the relay will close when the measurement goes above 50% of the analyzer range.

Loss of Sample 1 – The relay will close when the flow on Sample 1 is lost.

Loss of Sample 2 – The relay will close when the flow on Sample 2 is lost.

Fault Alarm – The relay will close when a Fault Alarm occurs such as

- Pressing the EMERGENCY STOP button. Alarm is cleared by pressing RESET in the RUN window.
- Reagent level falls below 4%. Alarm Cleared by refilling reagent bottles and setting the level to 100%.

Cycle Command – When testing the relay, set the relay mode to “Cycle Command”.

GO to the Display screen and press the Manual button.

Scroll through the options and select Relay #1.

Set the activation duration and press ON.

The Relay #1 contacts will close for the designated duration.

6 OPERATION

Colorimetry is a relative method, therefore an initial calibration is needed before measurement can be performed. This is done using standard solutions and analyzing them in the same way as the sample.

In order to ensure correct measurement performances, the analyzer should be calibrated periodically. The blank is taken with DI water. The system slope is controlled by a comparison to a standard solution of known concentration.

Calibration allows the analyzer to adjust:

- Blank of the system
- Slope of the system (factor calibration)

The calibration can be done manually or automatically.

6.1 REAGENTS PRIME

Prior to the initial calibration of the analyzer, the reagent lines must be primed. This procedure should also be performed every time the reagents are refilled or replaced.

1. Login with the 1st level service password (1111).
2. Press the DISPLAY button on the touchscreen and then press the button MANUAL STEP.
3. Select SAMPLE function for 20 seconds.
4. Select ADD REAG (1,2,3) functions for 40 seconds each in order to prime the three reagent lines. Visually confirm that reagent is being drawn into the lines and into the flowcell. If no reagent is seen, it may be necessary to repeat the ADD REAG function.
5. Select DRAIN function for 5 seconds.
6. Select SAMPLE function for 20 seconds.
7. Repeat steps 5 and 6 to rinse the flowcell.
8. Check the drain tube of the pinch valve is correctly positioned and select the DRAIN function for 5 seconds.

6.2 BLANK CALIBRATION

A blank calibration should be performed after reagent replacement and every time a manual calibration is required.

1. Login with the 1st level service password (1111).
2. Disconnect the sample tubing from the fast-loop reservoir and connect it to a DI water source.
NOTE: It is critically important that the DI water used for blank calibration contain the lowest possible Filming Amine concentration. Use of laboratory grade water produced using a mixed bed deionizer is required if available.
3. Perform an analysis cycle by pressing the RUN Menu and selecting CH 1.
 - It is recommended to proceed with a blank refreshment after performing three analysis cycles with DI water to flush the system.



- The absorbance detected by the analyzer is assumed to be absorbance produced by reagent(s) and DI water.
 - After each analysis cycle using DI water, record the “Absorb.” Value on the display screen (Fig. 5.4)
 - Continue performing analysis cycles using DI water until three readings are obtained that agree within 0.0020.
4. To store this value as the blank, from the PROGRAM menu, select the CALIBRATION Menu.
 5. Press and hold down the BLANK key.
 - This will refresh the stored BLANK value; it can be refreshed only after a completed analysis cycle with the analyzer in stand-by mode.
NOTE: Pressing the BLANK key will enter the current Absorbance value being read by the photocell, regardless of the process involved. Holding down the BLANK button at a time other than when the last reading was the blank analysis will create significant problems.
 6. Reconnect the sample line to the fast-loop reservoir.

6.3 SLOPE (FACTOR) CALIBRATION

A manual factor (slope) calibration should be performed during the initial start-up, after reagent replacement, and after any period of extended shut-down. The recommended and default setting for automatic calibration is approximately once per week.

1. Login with the 1st level service password (1111).
2. Connect the CAL tube to the calibration standard.
3. Check that the calibration standard is the correct concentration.
 - a. From the PROGRAM Menu, select CALIBRATION.
 - b. The concentration of the standard is displayed in blue.
 - c. To change the standard concentration, press the displayed standard value.
 - d. Type the new concentration and select ENT.
4. From the RUN Menu, select EXTRA. The analyzer will perform a calibration cycle and store the new calibration factor.
5. Perform an EXTRA Cycle two to three times with the calibration standard to ensure a repeatable calibration factor.
6. To check the value of the calibration factor, from the PROGRAM Menu select CALIBRATION to open the calibration menu window.

6.4 SINGLE ANALYSIS CYCLE

The analyzer can be set to run either in continuous analysis mode or single analysis mode. Follow the steps below to perform a single analysis cycle.

NOTE: When starting the analyzer for the first time or restarting it from any period of shutdown, do not proceed to run an analysis cycle until a calibration has been performed.

1. Connect the sample tubing to the fast-loop reservoir and turn on sample flow to the fast

- loop reservoir.
2. Check that the sample fills the fast loop reservoir so that the float switch rises and sample is being discharged from the overflow drain.
3. Perform an analysis cycle by pressing the RUN Menu and selecting CH 1.
 - The absorbance detected by the analyzer is used along with the blank and calibration values to determine a concentration in ppb.
4. When the analyzer has finished the analysis cycle, the concentration reading will be displayed on the main screen. The result can also be found in the data logger.
5. The analysis returns to standby mode and waits for another user command.

6.5 ONLINE MEASUREMENT

In online mode, the analyzer will run perform consecutive analysis cycles until it is manually stopped or the out of sample alarm is tripped.

NOTE: When starting the analyzer for the first time or restarting it from any period of shutdown, do not proceed to put the analyzer into online operation until a calibration has been performed.

1. Connect the sample tubing to the fast-loop reservoir and turn on sample flow to the fast loop reservoir.
2. Check that the sample fills the fast loop reservoir so that the float switch rises and sample is being discharged from the overflow drain.
3. Put the analyzer into online measurement mode by pressing the RUN Menu and selecting START ON LINE.
 - The absorbance detected by the analyzer is used along with the blank and calibration values to determine a concentration in ppb.
4. When the analyzer has finished the analysis cycle, the concentration reading will be displayed on the main screen. The new result and previous results are stored in the data logger (up to 500 measurement results).
5. The analyzer will wait the user defined amount of time (see Section 5.7.1) and then proceed to run additional analysis cycles.
6. To bring the analyzer out of online operation, press the RUN Menu. The top box where START ONLINE was previously, will now be blank and dark gray. Pressing this box will tell the analyzer to complete the current analysis cycle and go into stand-by mode at its completion.

6.6 GRAB SAMPLE

The grab sample feature allows the user to measure the concentration of an external sample.

NOTE: When starting the analyzer for the first time or restarting it from any period of shutdown, do not proceed to run a grab sample analysis until a calibration has been performed.



1. If the analyzer is in online operation, it is necessary to put it into standby mode.
 - Press the RUN Menu and select the START ON LINE button (blank, dark gray box on the top of the RUN Menu).
 - The analyzer will finish the analysis cycle that is currently in progress and go into standby mode.
2. Turn off sample flow to the fast loop reservoir.
3. Disconnect the sample tubing from the fast-loop reservoir and connect it to the grab sample source.
 - The grab sample source should have at least 200 ml of sample present.
4. Perform an analysis cycle by pressing the RUN Menu and selecting CH 1.
5. When the analyzer has finished the grab sample analysis cycle, the concentration reading will be displayed on the main screen. The result can also be found in the data logger.
6. The analysis returns to standby mode and waits for another user command.
7. When the user is finished with the grab sample analysis, make sure to reconnect the sample tubing to the fast loop reservoir.
8. Turn on sample flow to the fast loop reservoir.
9. Put the analyzer back into online operation mode by pressing the RUN Menu and selecting START ON LINE.

6.7 EMERGENCY STOP

The analyzer has an emergency stop function that will stop the analyzer immediately during any analysis cycle that it is performing.

1. Press the RUN Menu.
2. Select EMERGENCY STOP.
 - The analyzer will stop its current function and return to the main display screen.
 - The emergency stop fault alarm will be activated.
3. To put the analyzer into standby mode after an emergency stop, press the RUN Menu.
4. The menu will now show RESET in the position that emergency stop was listed previously.
5. Select RESET to deactivate the alarms and return the analyzer to the main display screen in standby mode.

NOTE: After initiating an emergency stop, there may be sample and reagents remaining in the analyzer. It will be necessary to flush the system before performing a new analysis cycle.

7 MAINTENANCE

7.1 SCHEDULED MAINTENANCE

Basic maintenance of the Waltron 3054 Analyzer requires that the reagent containers are refilled or replaced and that the colorimetric cell is cleaned on a regular basis. In addition, the user should perform a regular 'visual overall-check' of the wet part for immediate corrective measures, e.g. in case of leakages etc. Cleaning of the analyzer cabinet is best performed using a soft, non-aggressive cleaner.

The use of a logbook for cataloging reagent refilling, corrective measures and scheduled maintenance is strongly recommended.

During the performance of the basic maintenance work, as described in this chapter, the analyzer can not be operational. Prior to the maintenance work, all necessary precautions regarding personal safety (protective clothing, safety glasses etc.) are to be taken into consideration. Always be sure to label and rinse all connected tubing with water prior to removal.



Waltron Colorimeter is based on colorimetric analysis methods, using chemical solutions. Make sure that proper safety precautions are taken (e.g. using safety gloves and glasses) during handling the chemical solutions.

List of scheduled maintenance:

Visual check

Everytime that it is possible, visually check the following items:

- Liquid leakages
- Cell sample level (during cycle)
- Glass cell cleanliness condition
- Reagent level %

Monthly

- Visual overall check
- Colorimetric cell cleaning
- Reagent(s) replacement (reset reagent counters)
- Reagent pump(s) priming
- Calibration blank with DI water, slope with calibration solution

Quarterly (Every 3 Months)

- Pinch valve drain tubing replacement
- Peristaltic reagent pumps tubing replacement
- Peristaltic sample pump tubing replacement

**Annually**

- 3 ways valve cleaning
- Colorimetric cell o-ring replacement
- Fittings cleaning / replacement
- Mixing loop tubing replacement
- Reagent straw and sample tubing replacement
- Analyzer general inspection (for qualified personnel only)

Waltron provides all of the tubing and fittings required for scheduled maintenance as part of the yearly consumables kit, part number W3040-101.

Table 7.1: Scheduled maintenance reference chart.

Scheduled Maintenance	Frequency			
	Daily	Monthly	Quarterly	Annually
Visual check of FAULT alarm indicator	X			
Visual check of liquids enclosures for leakages detection	X			
Visual check of reagents level	X			
Sample fast-loop reservoir cleaning		X		
Colorimetric cell cleaning		X		
Reagents replacement (reset reagent counters)		X		
Pinch valve tubing replacement			X	
Sample pump tubing replacement			X	
Reagent pumps tubing replacement			X	
3 way valve cleaning and fittings replacement				X
Mixing loop tubing replacement				X
Colorimetric cell O-ring replacement				X
Reagent straw and sample tubing replacement				X
Analyzer general inspection (for qualified personnel only)				X

7.2 SAMPLE PUMP TUBING REPLACEMENT

The peristaltic pump head is located in the fluidics section. Before replacing the tubing, please read the hazards and dangers list in section 1 and health and reagents safe data sheets. It is also recommended to wear adequate clothes, gloves and eyes protection and take extreme care sample spills during tubing replacement.

Proceed as follows:

1. Stop the analyzer
2. Using the key, open the liquids enclosure
3. Manually unscrew the four wings nuts which hold the pump head in place.
4. Disconnect the pump tubing from its inlet and outlet fittings, taking extreme caution of liquid spills
5. Slide the pump head to the left and remove the pump head
6. Separate the two halves, taking care of the rotor, and remove the used tubing, taking caution of spills
7. Place the pump half containing the rotor in one hand and place the rollers in the 2, 6 and 10 o' clock positions. Place tubing in the outer port and against the two rollers as shown, keeping your thumb on the tubing to hold it in place, insert tubing key on the back of the rotor shaft and push in as far as possible. Tubing is now positioned in deep into the pump head body. With the key firmly pressed against the rotor, turn counterclockwise and push down while turning until tubing has surrounded the rotor
8. Tubing is now in place. Remove key and position other pump half into the rotor shaft and snap shut. Be careful not to pinch tubing between plastic pump halves
9. Check if the pump turns correctly using the key
10. Finger tighten the pump head slide it into the mounting screws moving the roller block with the key or with a screwdriver until the shaft aligns with the motor drive
11. Secure the four wing nuts by finger tightening until they have a firm mounting of the pump head
12. Restart the analyzer



Figure 7.1: Pump tubing replacement.



7.3 DRAIN PINCH VALVE TUBING REPLACEMENT

The drain tubing that is pinched closed by the drain valve should be replaced every 3 months due to wear on the tubing by the repeated pinching of the tubing by the valve. Failure to replace this tubing according to the scheduled maintenance cycle will result in tubing failure due to excessive wear. Drain tubing failure will not allow the proper level of sample to be maintained in the flowcell, leading to poor readings and calibration failure. Drain tubing failure will also result in the leakage of sample and reagents into the enclosure and onto the drain valve which can result in permanent damage to the drain valve pinch mechanism and other components.

To replace the drain tubing:

1. With the analyzer in stand-by mode, perform a manual command of DRAIN for 10 seconds to empty the flowcell.
2. Disconnect the drain tubing from the T fitting on the underneath of the analyzer enclosure.
3. Pull the drain tubing through the opening and into the enclosure.
4. Press the pinch valve in to release the tubing from the pinch mechanism and pull the tubing through the opening in the side of the pinch valve.
5. Disconnect the drain tubing from the bottom nipple of the flowcell. Take care that the flowcell is made of glass and is fragile.
6. Discard the drain tubing.
7. Connect the new drain tubing to the bottom of the flowcell.
8. While pushing in on the drain valve, push the drain tubing into the drain valve pinch mechanism.
9. Feed the drain tubing through the bottom of the enclosure.
10. Connect the drain tubing to the T fitting.
11. Perform a manual command of sample #1 for 25 seconds and once the flowcell is filled with sample, verify that the sample level is maintained by the drain valve. If the sample level is dropping with the drain valve closed, reposition the drain tubing in the pinch mechanism so that the level of sample in the flowcell is maintained.

7.4 REAGENT PUMP TUBING REPLACEMENT

The reagent pump tubing should be replaced every 3 months due to the repeated compression of the tubing by the pump rollers. Failure to replace this tubing according the scheduled maintenance cycle will result in tubing failure due to excessive wear. Excessive wear of the reagent pump tubing will cause inaccurate reagent injection volumes, leading to poor results and failed calibration. Reagent pump tubing failure will lead to reagent leakages inside the reagent pump housing which will cause permanent damage to reagent pumps and other components.

To replace the reagent pump tubing:

1. With the analyzer in standby mode, pull the reagent straw from the reagent bottle and perform a manual command of add reagent #1 for 60 seconds to empty the reagent tubing of reagent.
2. Use the allen key to remove the 3 screws holding the reagent pump faceplate in place.
3. With the faceplate removed, pull the reagent tubing from the reagent pump along with the pump rollers.
4. Disconnect the reagent pump tubing from the reagent straw tubing and the flowcell cap tubing and discard.
5. Check pump rollers for signs of excessive wear and replace if necessary. The rollers



- should be replaced yearly.
6. Connect the smaller elbow fitting of the new reagent pump tubing to the flowcell cap tubing above the reagent pump and the larger elbow fitting to the reagent straw tubing at the bottom of the reagent pump.
 7. Firmly press the reagent pump tubing into the reagent pump housing at the inlet and outlet ports of the housing. Verify that the tubing fits properly into the reagent pump housing and is not too loose or too tight.
 8. Insert the first pump roller into the open space.
 9. From the manual commands menu, perform an add reagent #1 command for 1 second. This should rotate the first pump roller into place against the tubing and open a spot for the second pump roller to fit.
 10. Repeat the previous step to insert the third roller.
 11. Replace the reagent pump faceplate using the three screws. Note that over-tightening could result in cracking the faceplate.
 12. Perform a manual add reagent #1 command for 60 seconds to fully prime the reagent line and verify that the tubing replacement was done successfully by checking for reagent droplets injection into the top of the flowcell by the end of the 60 second command.
 13. Repeat steps 2-12 for each remaining reagent pump.



8 ANALYZER SHUT-DOWN

It is important to know that the analyzer should run continuously, if possible. For a short downtime of the 3054 analyzer (from 1 to 3 days), it is recommended to put all the inlet tubing (reagents and sample source) in a DI water source and leave the unit running in these conditions.

For long shut down period, please proceed as follows:

1. Replace the reagent tubes in the container with distilled water and perform a priming of all the pumps with DI water.
 - a. Login with the 1st level service password (1111).
 - b. Press DISPLAY > MANUAL > STEP > ADD REAG 1,2,3 for 40 seconds.
2. Disconnect the sample line and fill the fast-loop reservoir (if present) with DI water.
3. Run the analyzer for at least 2 cycles with all of the reagent tubes placed in a DI water container.
4. Empty the hydraulic line of water.
5. Put the analyzer in stand-by mode.
6. Turn off the analyzer main power by disconnecting the plug from the power line.

9 TROUBLESHOOTING

For troubleshooting tips and solutions, refer to the HELP Menu. The HELP Menu can be found through the user interface of the analyzer and in Appendix B of this manual.

Table 9.1: Alarm descriptions.

Alarm Message	Alarm Description	Action Required
Reagent <10%	One or more reagent bottles is low	Check the level of the reagent bottles and refill as necessary
Zero Failure	The Reference Failed	Check the water level in the sample cell
Loss of Sample 1	The sample to stream 1 is lost	Check the flow of Sample #1
Loss of Sample 2	The sample to stream 2 is lost	Check the flow of Sample #2 Dual stream analyzers only
Emergency Stop	Someone felt it was necessary to press the Emergency Stop button	Determine why Emergency Stop was pressed, correct problem and then press the RESET button on the RUN window.
Cal Error	The Calibration Factor is out of Range.	<ol style="list-style-type: none"> 1. Check the level of the reagent bottles, 2. Make sure reagent pumps are primed 3. Check reagent pump dosage 4. Check Cal Sample level 5. Verify analyzer is draining properly
Result Alarm	Measurement is greater than the % on the Settings screen	The sample is out of range. Corrective action required.

10 SPARE PARTS

Table 10.1: Routine Maintenance Parts Listing.

Description	Part Number
Annual Consumables Kit	W3040-101
Pinch Valve Drain Tubing	W3040-055
Sample Pump Tubing	W3040-046
Sample Line Tubing	W3040-099
Peristaltic Reagent Pump Kit (tubing, fittings, rollers)	W3040-091

Table 10.2: Standards and Reagents Parts Listing.

Description	Part Number
Filming Amine Reagent #1	W1234-170
Filming Amine Reagent #2	W1234-171
Filming Amine Reagent #3	W1234-172

Table 10.3: Spare Parts Listing.

Description	Part Number
Pump Head 7016 – Sampling Pump	W9040-007
Pump motor 70-80 rpm 24 Vdc	W3040-015
External Reservoir - Fast loop with level switch	W3040-003
Peristaltic pump for reagents	W3040-057
Reaction quartz cell 26 mm	W3040-006A
Reaction cell block	W3040-117
Heater	W3040-009
Mixing pump	W3040-013A
Drain Pinch Valve	W3040-014
Flowcell Cap with Tubing and Fittings (3 Reagents)	W3040-056
3 Ways Valve (D351)	W3040-096
Sample Selection Block with 1 Valve (Single Stream Unit)	W3040-064
Sample Selection Block with 2 Valves (Dual Stream Unit)	W3040-065
Power supply – 24 Vdc	W3040-021
Touchscreen	W3040-022
Preamplifier photometer board	W3040-026
Led 525 nm	W3040-329
Electronics, Complete	W3040-097
Display Cable	W3040-093
Output Cable for User Connections	W3040-094

APPENDIX A – PANEL MOUNT SCHEMATICS

